

BLOCK C: Design with composites

1 Introduction

A composite material is made of a combining two or more materials to give a unique combination of properties. The constituent phases in the composite work together but remain in their original forms and are separated by a distinct interface. Matrix is the continuous phase in the composite and surrounds the other phases (dispersed). The performance of the composites is determined by the properties of the constituent phases, their relative amount, the geometry and distribution/orientation of the dispersed phases, and the interface, etc.

Most composites have been created to improve the combinations of mechanical characteristics such as stiffness, toughness, and strength. Therefore, the dispersed phases in the composites are often termed as the reinforcements (or reinforcing phases), as indicated in Figure 1. The reinforcements can be fibres, particulates, and whiskers, and the matrix materials can be metals, plastics, and ceramics. Among these variants, fibres reinforced polymer matrix composites are the most popular examples for various applications including automotive components, sporting accessories, as well as in aerospace and space industries. The growth in composite usage is driven by the increased awareness regarding product performance and increased competition in the global market for lightweight components.

In this block, our main efforts will be focused on fibre reinforced polymer composite, including short fibre and continuous fibre reinforcement.

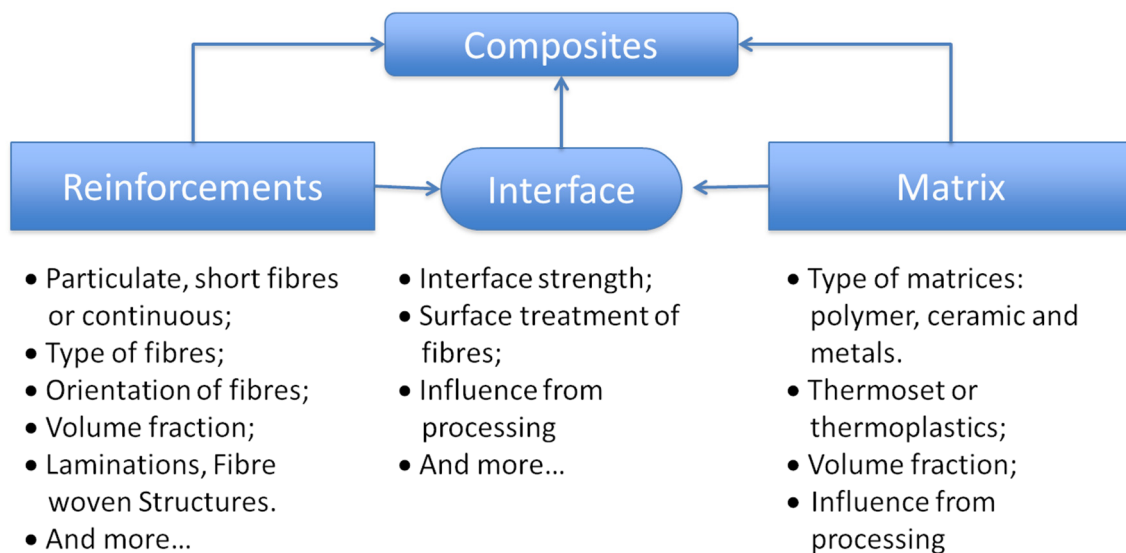

Figure 1 Overview of composite materials

2 Special features of composites

Composites have been routinely designed and manufactured for applications in which high performance and lightweight are required. They offer several advantages over traditional engineering materials.

(1) High specific strength

Composites have high specific strength (strength-to-weight ratio) over many other materials. The specific strength of carbon fibre composites is typically in the range of 3 to 5 times compared with steel and aluminium alloys. Due to the higher specific strength, the composite parts can be much lighter than their counterparts.

(2) Design flexibility

Composite materials offer increased amounts of design flexibility. One example is the ability to use a designable combination of polymers (resins) and reinforcement. Therefore, the mechanical and physical properties of a composite structure can be tailored for a particular application.

Furthermore, polymer composites can be moulded into complex shapes at a relatively low cost. Complex parts, appearance, and special contours, which are sometimes not possible with metals, can be fabricated using composite materials without welding or riveting the separate pieces. This increases reliability and reduces production times, as well as great manufacturing feasibility.

(3) Corrosion resistance

Composites products provide long-term resistance to water/humidity environments. Composites are the material of choice for outdoor exposure, chemical handling applications, and severe environment service.

(4) Temperature resistance

The temperature resistance of composite parts often depends on the temperature resistance of the matrix materials especially when the reinforcement is a ceramic, glass or metal and the matrix is a polymer. As a large proportion of composites use polymer-based matrices, then the temperature resistance of a composite part is normally limited by the properties of the polymeric matrix.

3. Reinforcements in the composites

3.1 Roles of fibres

Reinforcements (fibres) are important constituents of composite materials and give the necessary stiffness and strength to the composite. Fibres for composites come in many forms, from continuous fibres to discontinuous fibres, long fibres to short fibres, organic fibres to inorganic fibres. The most common reinforcement are glass, carbon, aramid and boron fibres. Typical fibre diameters range from 5 μm to 25 μm . Because of the small diameter, the fibres are normally flexible and easily conform to various shapes. The major roles of fibres in the composites can be summarised as:

- Carry the load;
- Provide structural properties to the composite, strength and stiffness;
- Improve thermal stability;
- Provide electrical conductivity or insulation;
- Influences formability and machinability of the composites.

3.2 Anisotropic and heterogeneous

Most engineering structural materials are homogeneous and therefore have isotropic properties. For a composite to be isotropic in a specific property, such as CTE or Young's modulus, all reinforcing elements, whether fibres or particles, have to be randomly oriented. This is not easily achieved for discontinuous fibres, since most processing methods tend to impart a certain orientation to the fibres. Thus fibre reinforced composites typically exhibit anisotropy. The result of this is that some properties may vary depending upon the directional of measurement. This can be used as an advantage by designing the anisotropic composite properties along the desired directions, e.g. strength, stiffness, thermal conductivity, and electrical conductivity, etc. In nature, wood and bone are typical examples of anisotropic composites.

Continuous fibres reinforced composites are usually used to deliberately make the composite anisotropic in a particular direction that is known to be the principally loaded axis or plane.

3.3 Fibre orientation

In fibre composites, the fibres reinforce more effectively along the longitudinal direction. Optimum strength and stiffness can be achieved in a composite by aligning the fibres parallel to the direction of loading. But the composite will perform poorly when the load is applied perpendicular to the fibres.

A method of producing an isotropic composite is to randomly orient the short fibres within the matrix. Another way of producing a more isotropic composite is to use multiple plies of continuous fibres with the direction of the fibres differing in each ply. Fibres can vary by 90°, 45°, or 30° angles to accommodate for the direction of the applied loads.

3.4 Influence of fibre length

The mechanical characteristics of a fibre reinforced composite depend not only on the properties of the fibres, but also on the degree to which an applied load is transferred to/from the fibres by the matrix phase. The interfacial bond between the fibres and matrix is critical to effective load transfer. Under an applied stress, the fibre-matrix bond yields a matrix deformation as shown in Figure 2. This makes the force on the fibre be minimum at the ends and maximum in the middle.

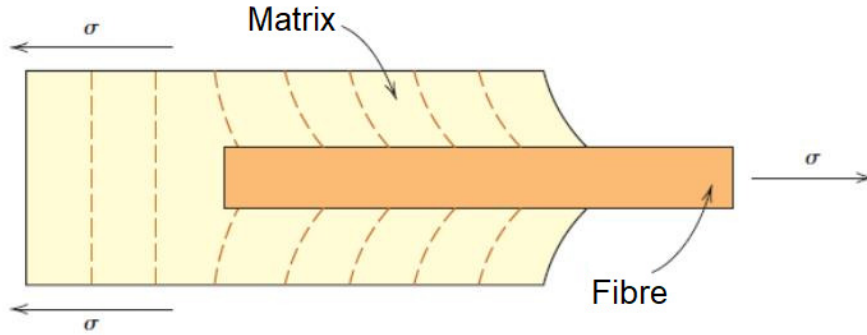

Figure 2 Deformation pattern in the matrix surrounding a fibre under tensile load (W.D. Callister, Materials Science and Engineering, 8th, John Wiley & Son, 2011)

For effective strengthening and stiffening of the composites, a minimum fibre length is required, which is termed as critical fibre length. The critical fibre length l_c is dependent on the fibre diameter d and its ultimate (or tensile) strength σ_f , and the fibre-matrix bonding strength τ_c (or the shear yield strength) according to $l_c = \frac{\sigma_f d}{2\tau_c}$. When a stress equal to σ_f is applied to a fibre having just the critical length, the maximum fibre load is obtained only at the axial centre of the fibre. As fibre length increases, the fibre reinforcement becomes more effective. For short fibres of lengths less than l_c , the matrix deforms around the fibre such that there is virtually no stress transference and little reinforcement by the fibre. To achieve effective strengthening and stiffening, the fibres must be larger than a critical length.

4 Rule of mixtures

Certain properties in multi-component material systems, including composites, may obey the “Rule-of-Mixtures”. Properties that obey this rule can be calculated as the sum of the value of the property of each constituent multiplied by its respective volume fraction in the mixture. In order to calculate properties by the rule of mixtures, the volume fraction of each constituent must first be determined. Volume fraction of the fibres is defined as $V_f = \frac{v_f}{v_c}$, and volume fraction of matrix V_m is

$$V_m = \frac{v_m}{v_c}.$$

Where v_f is the volume of the fibre and v_c is the volume of the composite, and the volume of the matrix component is v_m .

The sum of the volume fractions of all constituents in a composite must equal 1. In a two-component system consisting of fibres and matrix, then, the total volume of the composite is

$$V_f + V_m = 1.$$

4.1 Density of composites

The density of the composite in terms of volume fraction can be found by considering the weight of the composite to be composed of the weights of their constituent. The weights can be expressed in terms of their respective densities and volumes, $d_c v_c = v_m d_m + v_f d_f$. where d_c , d_m and d_f refer to the density of

the composite, matrix and fibres, respectively. For a two-component composite, $V_m + V_f = 1$, then This equation can be re-written as:

$$d_c = V_m d_m + V_f d_f$$

If the composite is not fully dense due to porosity, the influence of porosity volume fraction needs to be considered: $V_m + V_f + V_p = 1$ (V_p – Volume fraction of the porosity).

4.2 Thermal conductivity and electrical conductivity

Depending on how the dispersed phase is arranged inside the composite, the thermal conductivity and electrical conductivity may also be predicated. If continuous and unidirectional fibre reinforcement, the rule of mixture can also be applied.

For thermal conductivity K_c :

$$K_c = V_m K_m + V_f K_f$$

For electrical conductivity ρ_c :

$$\rho_c = V_m \rho_m + V_f \rho_f$$

Thermal and electrical energy can be transferred through the composite at a rate that is proportional to the volume fraction of the conductive materials.

4.3 Stress and elastic modulus parallel to fibres

The loading of a composite when measured in the direction of the fibres is referred to as the longitudinal loading. The stresses at which the fibres and the matrix fail determine the strength of a composite. The stresses in a composite can be determined by rule of mixture with some simplifying assumptions:

- The fibres are continuous, that is they extend for the length of the composite;
- The fibres are aligned in one direction only;
- The load is applied parallel to the direction of the fibres;
- There is perfect bonding between the fibre and the matrix thereby preventing interfacial slip.

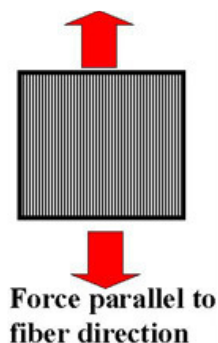

Figure 3 Tensile loading on a unidirectional composite part.

As shown in Figure 3, when longitudinal loading is applied on a unidirectional composite part, there is no interfacial slip between the fibres and matrix, so the deformation of the matrix and fibres is the same. The matrix and fibres have the same strain as the composite part:

$$\varepsilon_c = \varepsilon_m = \varepsilon_f$$

Where ε_c , ε_m and ε_f are the strain of the composite, matrix and fibres, respectively. Under this condition, the total load sustained by the composite F_c is equal to the sum of the load carried by the matrix F_m and the fibres F_f :

$$F_c = F_m + F_f$$

By considering the cross-sectional areas (A_c , A_m and A_f), then the respective stresses (σ_c , σ_m and σ_f) can be described as:

$$\sigma_c A_c = \sigma_m A_m + \sigma_f A_f$$

$$\text{Then, } \sigma_c = \sigma_m V_m + \sigma_f V_f$$

When each term is divided by its strain:

$$\frac{\sigma_c}{\varepsilon_c} = \frac{\sigma_m}{\varepsilon_m} V_m + \frac{\sigma_f}{\varepsilon_f} V_f$$

Therefore, an expression for the modulus of elasticity of a continuous and aligned fibre composite in longitudinal direction can be obtained, as

$$E_c = E_m V_m + E_f V_f$$

Where E_c , E_m and E_f refer to the elastic modulus of the composite, matrix and fibres, respectively. It is also shown that for longitudinal loading, that the ratio of the load carried by fibres/matrix is:

$$\frac{F_f}{F_m} = \frac{E_f V_f}{E_m V_m}$$

If we consider the strength characteristics of continuous and aligned fibre reinforced composites that are loaded in the longitudinal direction, then the tensile strength is normally taken as the maximum stress of the stress-strain curve, as shown in Figure 4. The maximum stress point often corresponds to fibre fracture and marks the onset of composite failure. In a normal case, the fibres will fail before the matrix. Once the fibres have fractured, most of the load will be transferred to the matrix, so that the composite can no longer sustain the desired stress. So the strength of the composite can be expressed as

$$\sigma_c^* = \sigma_m V_m + \sigma_f^* V_f$$

Where σ_m is the stress in the matrix at the fibre failure, and σ_f^* is the fibre tensile strength.

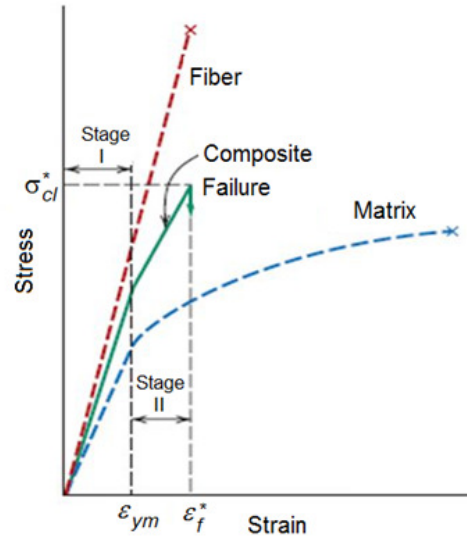

Figure 4 Stress-strain curve of a unidirectional composite under tensile loading along the longitudinal direction.

4.4 Stress and elastic modulus under transverse loading

A continuous unidirectional fibre composite may be loaded in the transverse direction of the fibres. In this case, the stress σ to which the composite, as well as both phases, are same, that is

$$\sigma = \sigma_c = \sigma_m = \sigma_f$$

And the strain or deformation of the entire composite ϵ_c is $\epsilon_c = \epsilon_m V_m + \epsilon_f V_f$

As $\epsilon = \sigma/E$,

$$\frac{\sigma}{E_c} = \frac{\sigma}{E_m} V_m + \frac{\sigma}{E_f} V_f$$

Then

$$\frac{1}{E_c} = \frac{V_m}{E_m} + \frac{V_f}{E_f}$$

Therefore,

$$E_c = \frac{E_m E_f}{V_m E_f + V_f E_m}$$

5 Reinforcing fibres

5.1 Typical fibres for composites

Many different fibres are manufactured for the reinforcement in composite, and their typical properties are given in Table 1. Overall, the manufacture of fibres involves a number of processing steps and the variability of properties from one fibre to another is significant.

Table 1 Typical properties of fibres

Fibre Type	Density (kg m ⁻³)	Modulus (GPa)	Tensile Strength (GPa)	Elongation (%)
E-Glass	2.54	72.5	1.72-3.45	2.5
Kevlar 49	1.45	117	2.27-3.80	1.8
Carbon (HS)	1.80	227	2.80-5.10	1.1
Carbon (HM)	1.80-1.86	370	1.80	0.5
Carbon (UHM)	1.86-2.10	350-520	1.00-1.75	0.2

Glass fibres – are the most common and the least expensive, with high strength, low stiffness and high density. Glass-fibre reinforced polymer (GFRP) consists of 30-60% glass fibres by volume. E-glass is the most commonly used fibre for the fibre reinforced polymer composites, known in the industry as a general-purpose fibre for its strength and electrical resistance. S-glass is a high strength grade, where high strength, high stiffness, extreme temperature resistance, and corrosive resistance is needed. Glass composites are normally used where the higher stiffness of carbon or Kevlar (aramid) fibres are not required.

Carbon (graphite/carbon) fibres – are by far the most widely used fibres for high-performance applications. They are more expensive than glass fibres, but have lower density and higher stiffness with high strength. The composite is often called carbon-fibre reinforced polymer (CFRP). Carbon fibres are produced from variety of precursors. The mechanical properties vary greatly with the precursor used and the processing conditions, as these determine the perfection and alignment of the crystals. In fibre technology, graphite is the most important structural form of carbon. The graphitic structure consists of hexagonal layers, in which the bonding is covalent and strong in the layer, while the inter-layer bonds are weak (van der Waals bonds).

Boron fibres – consist of boron deposited on tungsten fibres or carbon filament. Boron fibres provide great strength and stiffness, and possesses excellent compressive properties and buckling resistance. They have resistance to high temperatures, but are heavy and expensive.

Aramids (Kevlar) fibres – have one of the highest specific strength, and is a tough fibre undergoing plastic deformation before fracture, but absorbs moisture, and is expensive. The fibres are highly crystalline aromatic polyamide fibres that have the lowest density, and the highest tensile strength-to-weight ratio among the current reinforcing fibres. They also provide exceptional impact resistance and good elongation (higher than carbon, but less than glass), and are renowned for performance in bulletproof vests and other armour and ballistic applications. These properties also make Kevlar fibre an excellent choice for helicopter rotor blades, solid rocket motors, and other parts that must withstand high stress and vibration.

The structural properties of composite materials are derived primarily from the fibre reinforcement. Fibre hybrids (combination) capitalize on the best properties of more than one fibre type and can reduce raw material costs. Hybrid composites that combine carbon/aramid or carbon/glass fibres have been

used successfully in ribbed aircraft engine thrust reversers, telescope mirrors, driveshafts for ground transportation, and in the infrastructure arena, column-wrapping systems that reinforce concrete structural members.

5.2 Carbon fibres

In advanced composites, carbon fibres are the material of choice. Carbon is a very light element, with a density of about 2.3 g/cm^3 and its stiffness is considerable higher than glass. Carbon fibres can have up to 3 times the stiffness of steel and up to 15 times the strength of construction steel.

Carbon fibres have high chemical resistance and corrosion resistance at temperature up to $450 \text{ }^\circ\text{C}$ in air. Above $450 \text{ }^\circ\text{C}$, oxidation of the carbon element occurs and leads to the degradation of carbon fibres. In a non-oxidizing environment, high tensile strength and modulus can be maintained at a very high temperature (e.g. $>2000 \text{ }^\circ\text{C}$).

Carbon fibre market is dominated by polyacrylonitrile (PAN)-based and pitch-based carbon fibres. They have different strengths with processing methods and conditions, and there is always a trade-off between the strength and modulus. PAN refers to polyacrylonitrile, a polymer fibre of textile origin, and PAN-based fibres are most widely used for the fabrication of carbon fibres. Pitch fibres are obtained by spinning purified petroleum or coal tar pitch, and tend to have high modulus but lower strength. The fabrication of carbon fibres is illustrated in Figure 5, and there are three key operations involved: oxidization, carbonization and graphitization.

- (1) Precursor fibres stabilized at about $200\text{--}400 \text{ }^\circ\text{C}$ in the air by an **oxidization** process.
- (2) Then subjected to a high-temperature treatment (**carbonization**) at around $1,000 \text{ }^\circ\text{C}$ in an inert atmosphere to remove hydrogen, oxygen, nitrogen, and other non-carbon elements. This step is often called carbonization.
- (3) Carbonized fibres can be further **graphitized** at an even higher temperature up to around $3,000 \text{ }^\circ\text{C}$ to achieve higher carbon content and higher Young's modulus in the fibre direction. The properties of the resultant carbon/graphite fibres are affected by crystallinity, crystalline distribution, molecular orientation, carbon content, and the amount of defects.

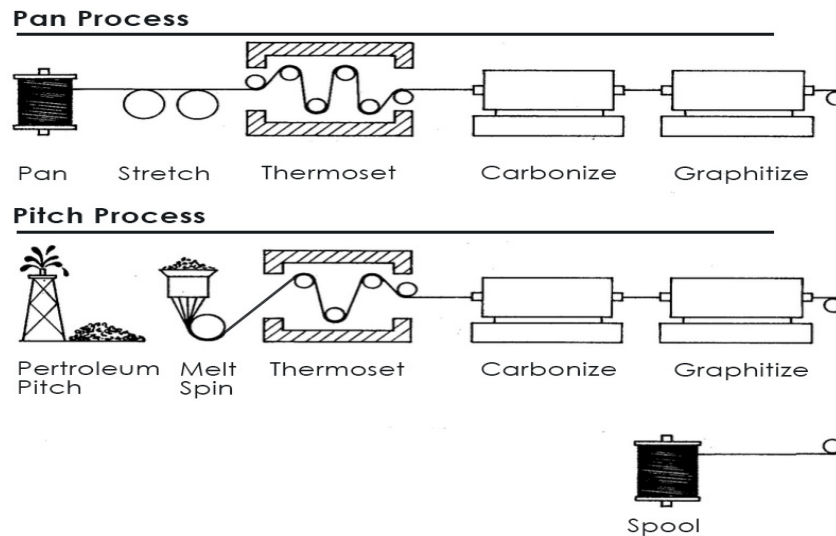

Figure 5 Fabrication of carbon fibres from PAN and Pitch precursors

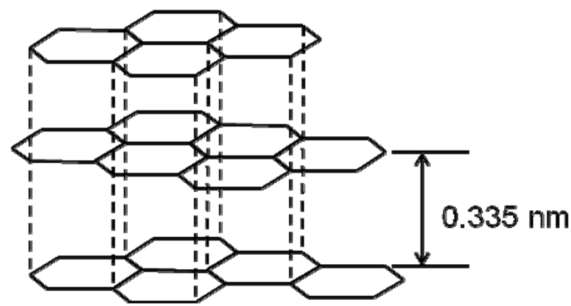

Figure 6 Schematic diagram of graphitic structure

Depending on the fabrication process and the precursor used, the layer planes in carbon fibre may be either graphitic or turbostratic structure, or a hybrid structure of both. As shown in Figure 6, in graphitic crystalline regions, the layer planes are stacked parallel to one another in a regular fashion. The graphitic structure in carbon fibre results in tensile modulus, as well as the highly anisotropic mechanical properties, which gives designers the ability to control the strength and stiffness of components by varying the orientation of the fibres. In general, high treatment temperature would increase the graphitization in carbon fibres, as thus the modulus, but reduce the strength. In a turbostratic structure, the parallel graphene sheets are stacked irregularly or haphazardly folded, tilted or split, which is typical when using a PAN precursor. In contrast with graphitic form, turbostratic structure in carbon fibres normally leads to higher strength.

6 Matrix

In a composite, the matrix surrounds the fibres and thus protects those fibres against chemical and environmental attacks. For fibres to carry maximum load, the matrix has a lower modulus and higher elongation than the reinforcement. The matrix determines the service operating temperature of the composite as well as processing parameters for composite manufacturing.

6.1 Role of matrix

Composite matrix can be polymers, ceramics, metals or carbons. Polymer matrices are the most widely used for composites in commercial and high-performance aerospace applications. Ceramic and metal matrices are typically used in high-temperature environments, like engines. Carbon as a matrix is used in very high-temperature applications like carbon-carbon brakes. In general, the role of matrix can be summarised as:

- Binds the fibres together, and protect the fibres;
- Transfer loads to and from fibres;
- Provides rigidity and shape to the structure;
- Isolates fibres to slow crack propagation;
- Surface quality, corrosion and wear protection for fibres.

For polymer matrix composites, the matrix plays a minor role in the tensile load-carrying capacity. But the selection of matrix has a major influence on the compressive, interlaminar shear, and in-plane shear properties of the composites.

6.2 Thermoset and thermoplastic polymer matrices

Polymers are divided into two broad categories: thermosets and thermoplastics. Thermoset polymers (resins) once cured cannot be remelted or reshaped. After curing, 3D molecular chains will be formed, termed as cross-linking. Thermoset resins provide easy processability and better fibre impregnation because the liquid resins before curing are ideal for the various processes. Thermoplastic polymers can be melted by heating and solidified by cooling, which renders the capability of repeated reshaping. Thermoplastic molecules do not cross-link and therefore they are flexible and reformable. In general, thermoplastic polymers are more ductile than thermosets, and are used for a wide variety of non-structural application.

The processing and defects in a composite component strongly depend on the processing characteristics of the matrix. When determining the matrix for a composite component, there are three key factors to be considered:

(1) Wettability to fibres:

- Thermosetting polymers: The low molecular weight of uncured resins in the liquid state results in exceptionally high molecular mobility, low viscosity, during processing. This mobility enables the resin to quickly wet the surface of carbon fibre, to ensure the desired properties.
- Thermoplastic polymer: high viscosity in its molten state, due to the high molecular weight.

(2) Processing temperature:

- Thermosetting polymers can be cured from room temperature to 200°C.

- For high-performance thermoplastics, such as polyimide (PI), polyethersulfone (PES), polyetheretherketone (PEEK), the processing temperature typically ranges from 300 to 400°C

(3) *Generic Properties:*

- Thermosetting polymer: Hard, higher usage temperature.
- Thermoplastic polymer: Soft, lower usage temperature.

Thermoset resins offer greater thermal and dimensional stability, better rigidity, and higher electrical, chemical and solvent resistance. Also because of the better processability, thermoset resins are more popular to be used as matrices for composite components.

6.3 Typical thermoset resins

Thermoset resins, such as epoxies, polyesters and phenolics, are the most commonly used matrices in continuous or long-fibre reinforced composites.

- *Phenolics* have excellent flame-resistance, heat and chemical resistance, and electrical insulation characteristics. Phenolics offer low density, good thermal insulation, outstanding durability and ease of formability to complex contours, and often used in circuit board applications. Phenolic resins are ideal for high-temperature applications where parts must meet fire safety, smoke emission, combustion and toxicity requirements.
- *Epoxies* are the most widely used resins from many applications, from aerospace to sporting goods, benefitting from the high strength and stiffness compared with other polymers and its versatility is useful for many resin based systems. This is because epoxies exhibit a broad range of properties and processing capabilities, as well as good adhesion to a variety of substrate materials. Epoxy-based composites provide good performance at room and elevated temperature up to approximately 180 °C.
- *Polyester* is a low-cost resin system and offers excellent corrosion resistance. The operating service temperature for polyesters is lower than for epoxies. Polyesters can be a thermosetting resin or thermoplastic resin, depending on the molecular structures. Polyesters are slightly weaker than epoxy but about half the price, produces emission when curing, and used in everything from boats to RVs to piping to automotive bodies (e.g. corvette).

6.4 Epoxy resins and the related cross-linking reactions.

Epoxy resin are among the most selected matrix materials for many fibre composites. This is true for several reasons:

- Epoxy resin adhere well to a wide variety of fillers, reinforcing agents and substrates;

- The wide variety of available epoxy resins and curing agents can be formulated to give a broad range of properties after cure and to meet a diverse range of processing requirement;
- The chemical reactions between the epoxy resin and curing agents do not release any volatiles or water, so that the shrinkage after cure is usually lower than phenolic or polyesters resins;
- Cured epoxy resins have good resistance to chemical and environmental attacks.

Epoxy resins are characterized by having two or more epoxide groups per molecule. The structure of epoxide group is presented as:

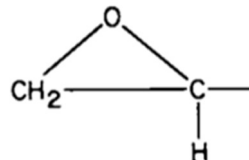

Most commercial epoxy resins have the general chemical structure:

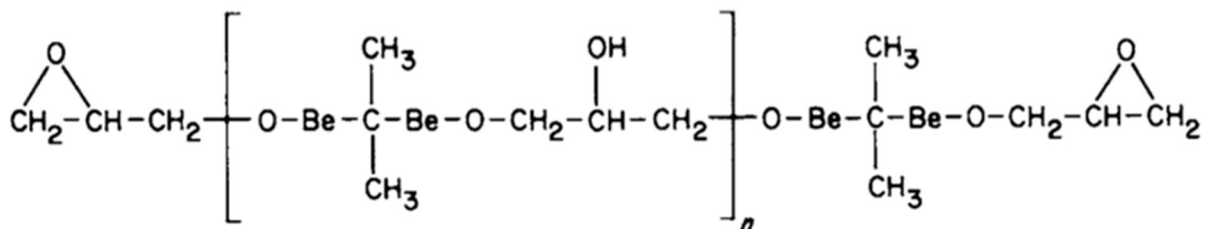

where Be = benzene ring. For liquids, n is usually less than 1; for solid resins, n is 2 or greater.

The epoxy group can bond chemically with other molecules, forming a large three-dimensional network. This process is named as curing, which changes a liquid resin into a solid. Curing of an epoxy resin requires a cross-linking agent and/or a catalyst. Cross-linking agents of epoxy include amines, anhydrides, and aldehyde condensation products.

In the curing reaction, the epoxide ring is opened (called ring scission) and a donor hydrogen from an amine or hydroxyl group bonds with the oxygen atom of the epoxide group. For example, ethylene diamine is an amine which can serve as a cross-linking agent:

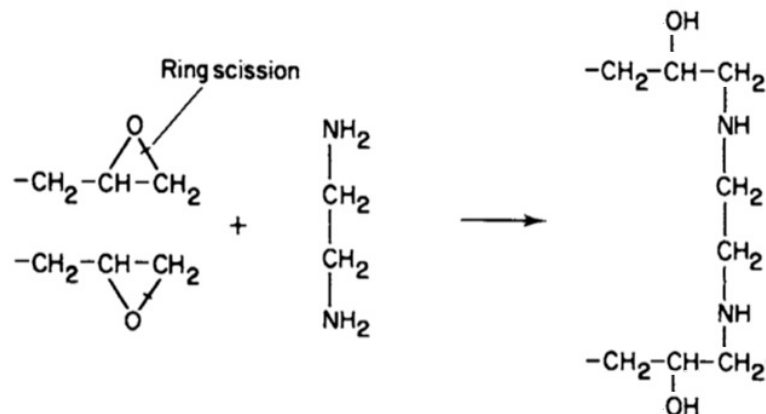

Further reactions form the complete cross-link network:

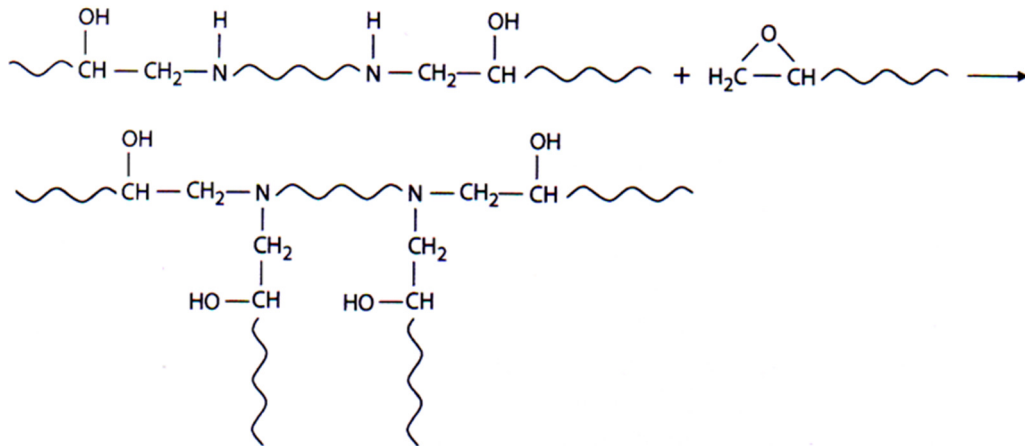

Curing time and temperature depend on the type and amount of curing agent. With some curing agents, the reaction initiates and proceeds at room temperature; but with others, elevated temperatures are required. Accelerators are sometimes added to the liquid mix to speed up a slow reaction and shorten the curing time. The correct relative amounts of epoxide and amine curing agent must be followed to obtain the complete network. If there is an imbalance, unreacted functional groups will be retained and the full properties will not be developed.

The properties of a cured epoxy resin depend principally on the cross-link density (spacing between successive cross-link sites). In general, the tensile modulus, thermal stability as well as chemical resistance are improved with increasing cross-link density; but the strain-to-failure and fracture toughness are reduced. Factors that control the cross-link density are the chemical structure of the starting liquid resin, the functionality of the curing agent, and the reaction conditions, such as temperature and time.

7 Fibre-matrix interface and surface treatment of fibres

7.1 Fibre-matrix Interface

To obtain desirable properties in a composite, the applied load should be effectively transferred from the matrix to the fibres via the interface. Thus the reinforcements must be strongly bonded to the matrix if their high strength and stiffness are to be imparted to the composite. The fracture behaviour of composites is also dependent on the bonding strength of the interface as the interface bonding strength may affect crack propagation, as shown in Figure 7. A weak interface results in a low stiffness and strength but interface debonding may induce more energy adsorption which would benefit fracture toughness; while strong interface produces high stiffness and strength but often leads to a low resistance to fracture, i.e., brittle behaviour.

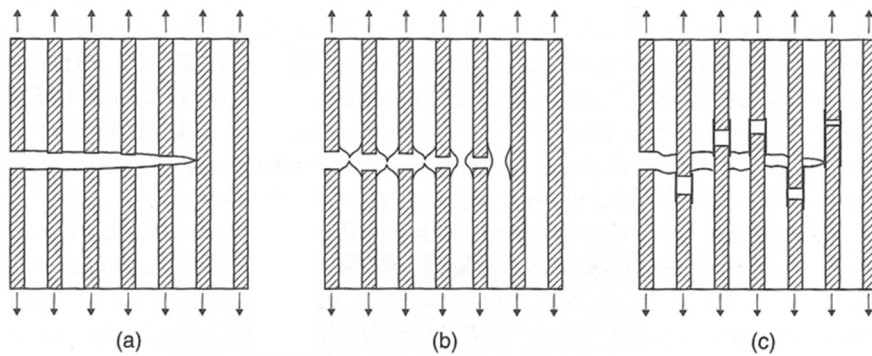

Figure 7 Relative extent of longitudinal splitting (a) development of the crack; (b) limited debonding leading to brittle fracture; (c) extensive debond leading to broomlike failure.

For forming a good interface bonding, the matrix material must be able to "wet" the fibres to ensure good contact. Bonding with the matrix can be either weak van der Waals forces or strong covalent bonds, as well as mechanical interlocking. Some relevant factors can be summarised as follows:

- Compatibility of resin and fibres (Wettability)
- Surface finish of fibre during fibre manufacture
- Imperfections on fibre surface
- Curing of matrix

7.2 Fibre surface treatments

The primary function of fibre surface treatment is to improve the bonding between the fibres and the polymer matrix, which are critically important for effective stress transfer from the matrix to the fibre and vice versa.

Glass fibres: chemical coupling agents, such as silanes, are used with glass fibres: (1) to improve the fibre-matrix interfacial strength through physical and chemical bonds, and (2) to protect the fibre surface from moisture and reactive fluids. Schematic of the bonding action on the surface of glass fibres are shown in Figure 8.

Carbon fibre surfaces are chemically inactive and normally needs treatment to form surface functional groups that promote chemical bonding with the polymer matrices. The surface treatment may also increase the surface area by creating micro surface roughness or pits on the fibre surface, leading to the increase of surface area and thus provides a larger number of contact points for fibre-matrix bonding increasing the physical bonding.

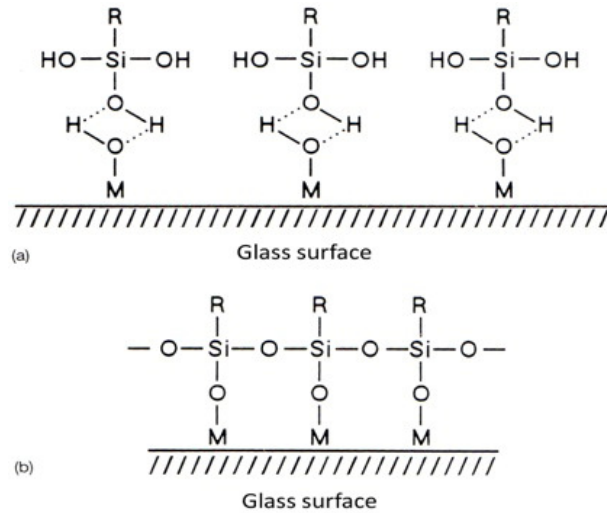

Figure 8 Action of coupling agent on glass fibres: (a) hydrogen bonding between hydroxide bonds in silanol and metal hydroxide in glass; (b) Polysiloxane bonded to the glass surface. M represents metal element in glass fibres, Si, Fe, and Al, etc. (SK De et al, Short Fibre polymer composite, Woodhead Publishing Limited, 1996).

Oxidation is a typical method to produce functional groups on the carbon fibre surface for the fabrication of polymer composites. The oxidation can be carried out either in an oxygen-containing gas (air, oxygen, carbon dioxide, and ozone, etc.), or in an oxidizing liquid. Oxidation in gas environment at very high temperature may cause excessive pitting on the fibre surface and reduce the fibre strength. Nitric acid is the most common liquid used for the liquid-phase oxidation. The treatment effectiveness depends on the acid concentration, treatment time, temperature, and fibre type.

Applying wetting agent and sizing is another common method for the surface treatment of carbon fibres, to provide functional groups capable of forming good bonds with the resin matrix. A sizing layer (coating) can be deposited on the fibre surface, usually by passing a solution or emulsion consisting of polymeric components. The sizing can alter the handleability of carbon fibres which includes fibre protection, fibre alignment and fibre wettability.

8. Manufacturing of polymer matrix composites

Composites manufacturing can be divided into two main categories: processes for thermoset composites and processes for thermoplastic composite. Processing of thermoset composites is much easier because the initial resin system is in the liquid state in which fibres are easy to wet with the resins. In commercial applications, thermoset composite parts dominate the composite market. Some typical manufacturing techniques for polymer composites will be introduced as in the following sub-sections.

8.1 Lay-up process

Wet Lay-up:

Wet lay-up is a flexible process and allows the user to optimise the part by placing different types of fabric and mat materials. As the reinforcement is placed manually, it is also called hand lay-up process.

In wet lay-up process, fibres (fabric) are normally arranged/placed in the mould manually and pour with liquid resin. The lay-up process includes the following steps: (1) Laying the fabric in the mould; (2) Saturating the fabric with mixed liquid epoxy; (3) Adding another ply of fabric; (4) Repeat the application of resin and working as above; (5) Continue until all the plies are in place, excess resin has been worked to the edges, and the composite conforms to the mould. Finally, the curing process occurs at room temperature or at elevated temperature. Sometimes vacuum bagging is used to create good consolidation between the layers as well as to remove the entrapped air. For small parts, they can be put into an autoclave and external pressure can be applied to ensure good consolidation.

The wet lay-up process is a traditional composite manufacturing technique with some clear advantages: (1) Very low capital investment is required; (2) Simple and versatile, applicable to various part sizes and geometries; (3) Cost of making the prototype is low and the fibre types and orientation can be easily selected/modified. The major limitation of wet lay-up is that the moulding has only one smooth surface. The lack of control over part thickness, void fraction, and resin content, means that the applications are typically for very low stressed parts which dimensional accuracy is non-critical.

Prepreg lay-up:

Prepregs are thin sheets of fibres impregnated with predetermined amount of uniformly distributed resin. Resin content in commercially available prepregs normally ranges from 30 % to 40 % by weight. In prepreg lay-up, prepregs are cut, laid down in the desired fibre orientation. Then the composite with the mold is put inside an oven or autoclave and then heat and pressure applied for curing and consolidation of the part.

Compared with wet layup which is hard to control the amount of resin, prepreg lay-up addresses this problem by impregnating fabric with a pre-mixed resin. Also, composite parts with higher fibre volume fraction can be fabricated using prepreg lay-up.

8.2 Resin transfer moulding (RTM)

RTM has gained great importance in the composites industry because of its capability to make small to large complex structures in a cost-effective manner. The process is a closed mould operation in which a dry fibre preform is used as the starting point. As indicated in Figure 9, in the RTM process, a pre-made fibre preform is placed into the mould cavity. A matching mould half is mated to the first half and the two are clamped together. Then a pressurized mixture of thermoset resin liquid is pumped/injected into the mould. After curing, the mould is opened and the part can be removed from the mould.

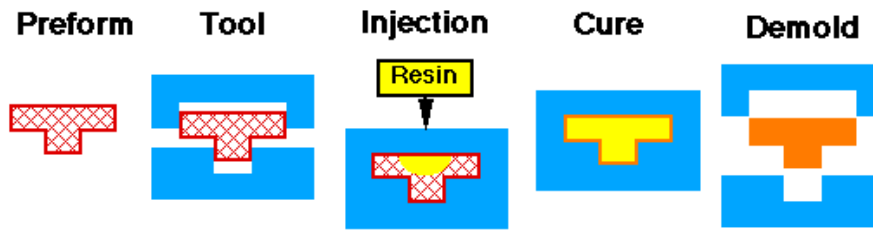

Figure 9 Processing steps of resin transfer moulding

RTM offers the fabrication of complex shape parts with controlled fibre orientation. Continuous fibres are usually used in the RTM process. The main issues in RTM are resin flow, curing and heat transfer in the porous preforms. During mould filing, the resin flows into the mould and experiences curing reactions, causing its viscosity to increase. After the fibre preform is completely saturated with resin, cure reactions continue to form a cross-linked structure. Some key features of RTM can be summarised as: (1) RTM is a vacuum-assisted, resin transfer process with a flexible solid counter tool for surface compression; (2) The process yields increased laminate compression, a high carbon-to-resin ratio; (3) Recommended for products with high modulus/strength-to-weight or requirements; (4) Parts can be produced with close dimensional tolerances.

8.3 Filament winding process

Filament winding is a process in which resin-impregnated fibre are wound over a rotating mandrel at the desired angle. A typical filament winding process is shown in Figure 10, in which a carriage unit moves back and forth and the mandrel rotates at a specified speed. By controlling the motion of the carriage unit and the mandrel, the desired fibre angle is generated. The process is suitable for making tubular parts. This process can be automated for making high-volume parts in a cost-effective manner. Filament winding is a very suitable process for making composite pressure vessels.

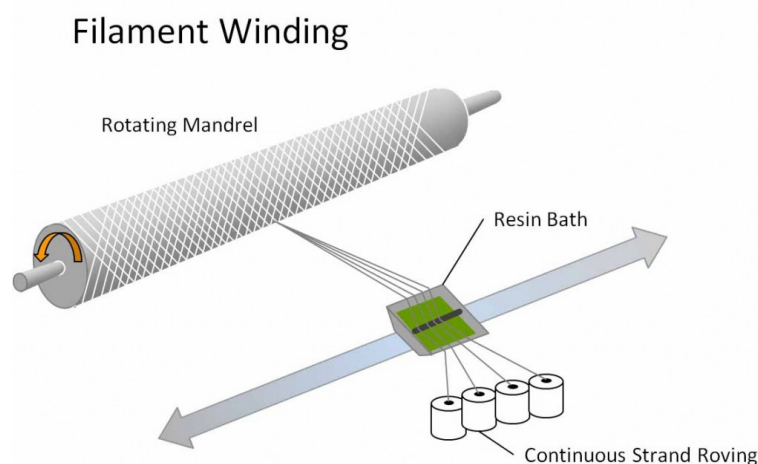

Figure 10 Schematic of filament winding process

8.4 Injection moulding for thermoplastic polymer composites

For many applications of polymer composites, the development of peak strength or stiffness properties are not the major requirement, then short fibres can be used as reinforcement, to reduce the manufacturing cost and increase the production rate. As a fast, high-volume, closed moulding process, injection moulding can be adapted for manufacturing short fibre reinforced polymer composites, especially for thermoplastics matrix, such as nylon. Unlike the thermoset matrix composite, no chemical reaction occurs during the processing of thermoplastic matrix composites. But the processing temperature required for thermoplastic matrix composites are much higher than the curing temperature for the thermoset matrix.

Injection moulding is a process that forces a measured amount of liquid fibre-filled resin into heated mould cavities. It is a high-volume manufacturing processing allowing the production of complex shapes in one shot. During the injection, due to the involvement of short fibres, the molten thermoplastic has much higher viscosity, which may cause difficulty in the injection moulding even with a high injection pressure. The typical fibre volume fraction in injection moulding is 30 %, and so a high fibre reinforcement cannot be achieved. For the same consideration, the length of the thermoplastic fibre pellets is normally no more than 10 ~13mm. Also, due to the high shearing action into the barrel and nozzle, extensive damage to the fibres may take place.

For fibrous reinforcements with a high aspect ratio, their orientation and distribution during the injection is very important. The orientation patterns in the composites are the result of the response of the fibres to the flow in the cavity during filling. As indicated in Figure 11, the fibre attempts to follow the fountain-like flow and their orientation is likely to follow a streamline. Weld lines are a particular concern in the injection of such fibre-reinforced polymers. The primary issue is the undesirable fibre orientation at the interface of two advancing flow fronts. Typically, the relative strength at weld line decreases with increasing fibre content and aspect ratio.

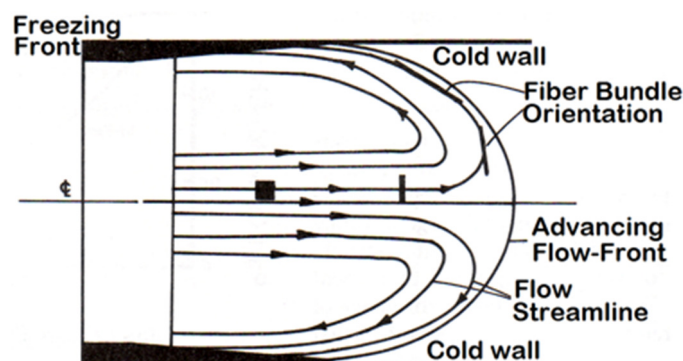

Figure 11 Fountain flow in injection moulding, showing fibre bundle behaviour along a streamline.

9 Relation of structure-property-process of polymer composites

9.1 Impregnation and porosity

In the manufacturing of polymer composites, completed impregnation of fibres with resins are always the most critical issue to be ensured. Poor impregnation would not only lead to the formation of high porosity, but also significantly deterioration of the mechanical properties of the composites. Besides the manufacturing method used, there are many factors that can affect the impregnation and can be modified, such as:

- Fibre volume fraction and preform design
- Resin viscosity during the process (resin type and process temperature)
- Wettability between carbon fibres and resin
- Process pressure
- Vacuum-assistance

Among the various defects in polymer composites, porosity (void) is normally considered as the most critical defect in influencing the required mechanical properties, such as tensile, compressive and flexural strengths. The presence of voids and dry spots would prompt the initiation and propagation of cracks, and influence the loading transfer inside the composites. With increasing porosity, the mechanical properties of composites decrease significantly. The most common reason for void formation is the inability of the resin to displace air from the fibre surface during the impregnation. Therefore during manufacturing, the factors related to the formation of porosity include:

- Gas formation during the curing process
- Remove of air and bubbles
- Resin viscosity
- Process pressure
- Vacuum level

9.2 Processing temperature

In composite manufacturing, the processing temperature is often determined by the curing behaviour of the matrix resin. For epoxy resins, the curing can be operated at room temperature or at an elevated temperature up to 150 °C. In general, higher temperatures produce a more complete reaction with a greater degree of cross-linking than lower temperatures. Note that, increasing the length of time for a lower temperature cure does not always yield the same degree of crosslinking as curing at a higher temperature. At a lower temperature, the cross-links slowly result in a more expanded network, and the mobility of any unreacted groups in the structure gradually decreases thus slowly migrating to open reactive sites. Extending the cure times tend not be harmful as the cure temperatures are well below the thermal degradation temperatures of the epoxy. Figure 12 shows the rheological change during the curing process in RTM, consisting the stages of filling, curing and post-cure. Sometimes, a step-wise

temperature can be used to control the three stages, to prevent excessive heat build-up from the exothermic curing reaction.

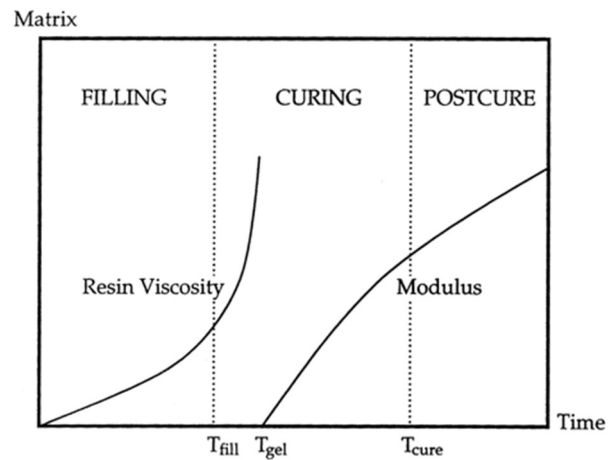

Figure 12 Rheological change during the curing process in RTM (Peter ST, Handbook of composites, Chapman & Hall, 1998).

10 Carbon-carbon composites

Carbon-carbon (C/C) composites consist of carbon fibres embedded in a carbon matrix. Continuous carbon fibres and short carbon fibres (carbon felts) are used as the reinforcement for strength and toughness. Similar to the polymer matrix laminates, the tailored arrangement of carbon fibres in selected orientations can be used to achieve the desired properties. The fibre construction includes unidirectional, bidirectional, three-dimensional, or multidirectional weaves and braids. C/C composites are remarkable materials since they combine toughness, low weight and refractory properties in a non-oxidative environment at high temperatures up to 2000 °C. In particular, their resistance to impact and thermal shock is excellent due to high thermal conductivity and low thermal expansion behavior. A severe limitation in the use of C/C composite is due to the oxidation of carbon which starts at temperatures as low as 500 °C.

The failure strain of the carbon matrix in C/C composite is lower than that of the carbon fibres. If the fibre-matrix interface bonding is appropriate (i.e. not strongest), matrix cracking at low strain will not produce immediate fibre failure; instead, there will be energy absorption due to debonding, fibre bridging, fibre fracture, and fibre pull-out, which offer the composite high fracture toughness. For example, a fully densified unidirectional C/C composite part shows fracture energy of about 2×10^4 J/m², while the fracture energy of engineering ceramics or graphite is $< 10^2$ J/m².

Chemical vapour infiltration (CVI) is a typical process for the fabrication of high-temperature carbon and ceramic matrix composites, reinforced by fibres. For the fabrication of C/C composite parts, the CVI process starts with the preparation of porous carbon fibre preform in the shape of the desired part.

As illustrated in Figure 13, the preform is heated in a furnace in the presence of hydrocarbon gases, such as methane. With the deposition of the hydrocarbon gases, a layer of pyrolytic carbon is slowly formed and deposited on the porous surface inside the fibre preform, which eventually builds up the continuous carbon matrix for the composite part. This process is often referred as densification.

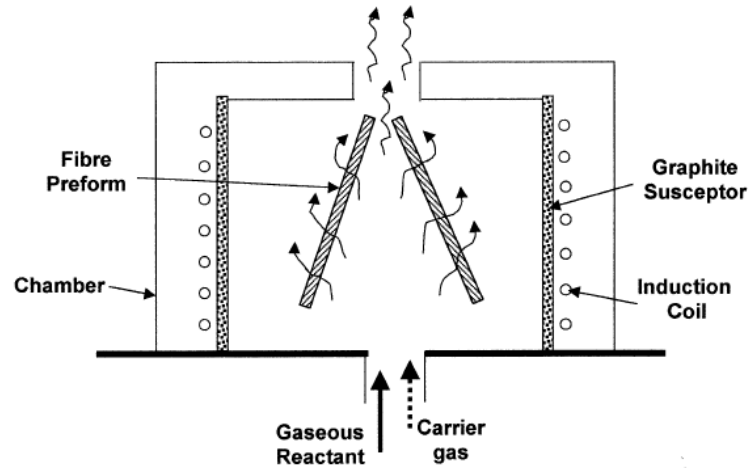

Figure 13 Schematic diagram of CVI process

C/C composite brakes were introduced on Airbus aircraft in mid 80's in particular to take benefit of their advantages over steel brakes, attributing from the following advantages:

- Lighter than steel
- Maintains its strength at high temperature
- Dissipates heat efficiently, higher energy absorption capability
- High friction at working temperature
- No distortion, and excellent wear resistance give long working lifetime.

References:

- [1] P.K. Mallick, *Fiber-reinforced composites: Materials, Manufacturing and Design*, 3rd Edition, CRC Press, 2008.
- [2] Sanjay K. Mazumdar, *Composites Manufacturing: Materials, Product, and Process Engineering*, CRC Press, 2002.
- [3] S.T. Peter, *Handbook of Composites*, 2nd Edition, Chapman & Hall, 1998.
- [4] F.L. Matthews, R.D. Rawlings, *Composite Materials: Engineering and Science*, Chapman & Hall, 1996.
- [5] George Lubin, *Handbook of Composites*, Van Nostrand Reinhold, New York, 1982.
- [6] Daniel Gay, Suong V. Hoa, *Composite Materials: Design and Applications*, 2nd Edition, CRC Press, 2007.
- [7] Pierre Delhaes, *Fibers and Composites*, Taylor & Francis, 2003.
- [8] William D. Callister, David G. Rethwisch, *Materials Science and Engineering*, 8th Edition, John Wiley & Son (Asia) Pte Ltd. 2011.

Selection of materials and shapes

The shape of a mechanical part may offer different mechanical efficiency to carry different modes of loading, e.g. bending, torsional and axial-compressive loads. This section extends the material selection to include the shape of the component. When shape is constant, standard indices guide the material selection. When different materials are available in different section shapes, the choice of the best combination becomes a very practical issue, and the indices including the shape factors guide the selection.

1 Shape selection

Figure S1 shows some typical section-shapes chosen for common modes of loading. These section shapes can provide good resistance for the modes of loading applied, respectively. It is clear that the best material-and-shape combination depending on the mode of loading. In axial tension, the area of the cross-section is important but its shape is not: All sections with the same area will carry the same load. Not so in bending: Beams with hollow-box sections or I-sections are better than solid sections of the same cross-sectional area. Similarly, torsion has its efficient shapes: Circular tubes, for instance, are more efficient than either solid sections or I-sections. To characterize this, a metric - a way of measuring the structural efficiency of a section shape is used, independent of the material of which it is made. An obvious metric is that given by the ratio ϕ of the stiffness or strength of the shaped section to that of a reference shape: e.g. a solid square section with the same cross-sectional area A , and thus the same mass per unit length m_l , as the shaped section (Figure S2).

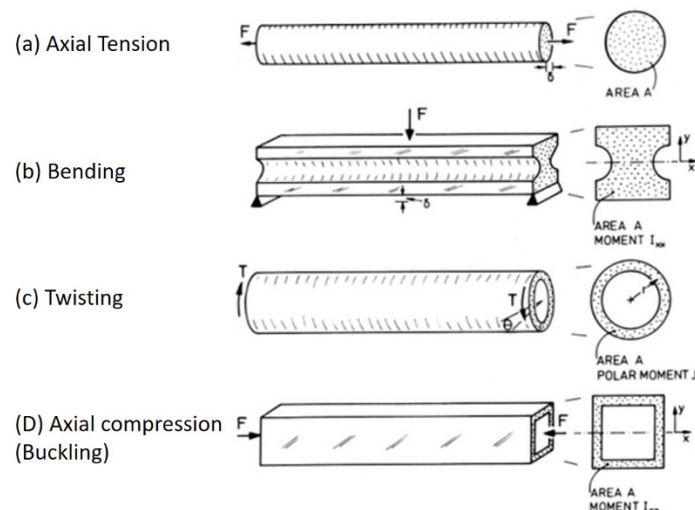

Figure S1 Common modes of loading and the section-shapes chosen

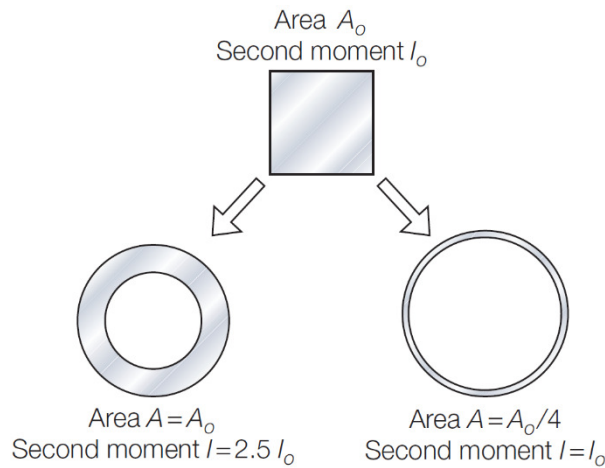
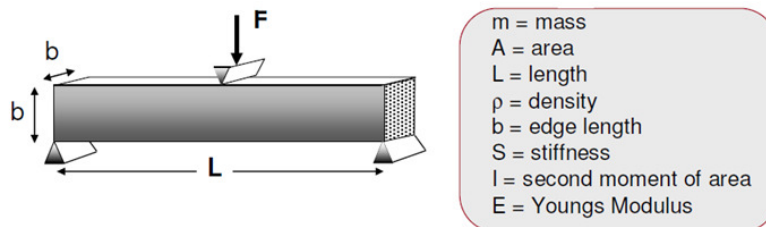

Figure S2 The effect of section shape on bending stiffness EI : a square-section beam compared: left, with a tube of the same area (but 2.5 times stiffer); right, with a tube with the same stiffness (but 4 times lighter).

2 Shape factor in elastic bending of beam

For bending of beam, the bending stiffness S of a beam is proportional to the product EI and can be given as

$$S \propto \frac{EI}{L^3}$$



The second moment of area, I_0 , for a reference beam of square section with edge length b and the section area A is simplified:

$$I_0 = \frac{b^4}{12} = \frac{A^2}{12}$$

The bending stiffness of the shaped section differs from that of a square one with the same area A by the factor ϕ_B^e where

$$\phi_B^e = \frac{S}{S_0} = \frac{EI}{EI_0} = 12 \frac{I}{A^2}$$

ϕ_B^e is called the shape factor for elastic bending. Shape factor is a dimensionless number that characterizes the efficiency of the shape, regardless of its scale, for a given mode of loading. The key features of shape factor are:

- Specific for each mode of loading;
- Independent of the material of which the component is made;

- Dimensionless (regardless of shape scale).

Figure S3 is a plot of I against A for values of ϕ_B^e . The contour for $\phi_B^e = 1$ describes the square-section reference beam. Those for $\phi_B^e = 10$ and $\phi_B^e = 100$ describe more efficient shapes, as suggested by the icons at the bottom left, in each of which the axis of bending is horizontal. But it is not always high stiffness that is wanted. Springs, cradles, suspensions, cables, and other structures that must flex yet have high tensile strength rely on having a low bending stiffness. Then we want low shape efficiency. It is achieved by spreading the material in a plane containing the axis of bending to form sheets or wires, as suggested by the contours for $\phi_B^e = 0.1$ and 0.01 .

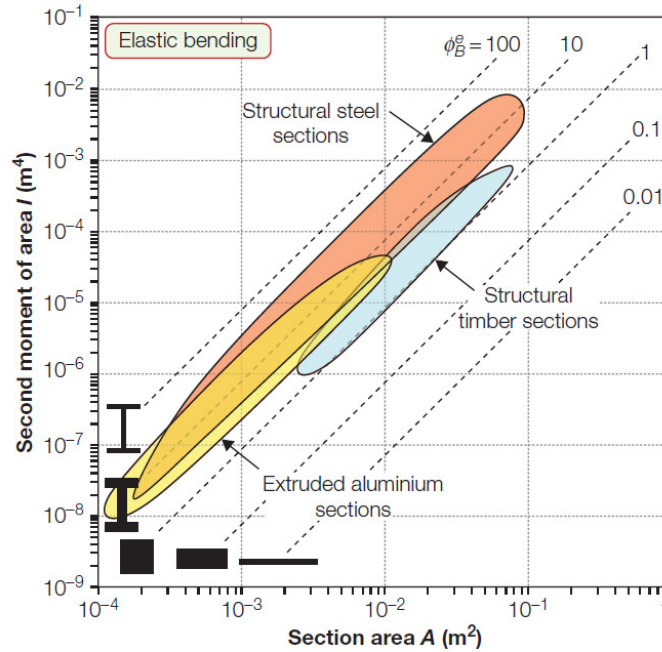

Figure S3 Second moment of area I plotted against section area A . Efficient structures have high values of the ratio I/A^2 ; inefficient structures (ones that bend easily) have low values.

To make stiff and strong structures, efficient shape factors have to be made which is often limited by two factors: (1) manufacturing constraints (processability of materials): the difficulty or expense of making an efficient shape, and (2) mechanical stability (local buckling) of shaped sections. Each material has its own upper limit of shape, and the values differ considerably. The upper limits for shape efficiency are important. They are central to the design of structures that are light or for which, for other reasons (e.g. cost, etc.), the material mass should be minimized.

For beams with the same shape (meaning the same value of ϕ_B^e), the best choice is the material with the greatest value of $E^{1/2}/\rho$. But if we want the lightest material-shape combination, it is the one with the greatest value of the index:

$$M_1 = \frac{(\phi_B^e E)^{1/2}}{\rho}$$

This index allows material-shape combination to be ranked.

For complex structures like bridges, if the mass of the structure, its length and its bending stiffness are known (as they are for large bridge-spans) and the density and modulus of the material of which it is made are known, the shape factors can be calculated. When using solid square as reference, the relation can be described as

$$m = \left(\frac{12S_B^*}{C_1} \right)^{1/2} L^{5/2} \left[\frac{\rho}{(\phi_B^e E)^{1/2}} \right]$$

Where S_B^* refers to the target stiffness, and C_1 is a constant that depends only on the way of the load distribution on the beam.

3 Graphical coselecting using indices

When material shape is considered, the material index for elastic bending can be re-written as:

$$M_1 = \frac{(\phi_B^e E)^{1/2}}{\rho} = \frac{(E/\phi_B^e)^{1/2}}{\rho/\phi_B^e} = \frac{E^{1/2}}{\rho^*}$$

When structured, it can be thought of as a new material with a modulus and density of:

$$E^* = \frac{E}{\phi_B^e} \text{ and } \rho^* = \frac{\rho}{\phi_B^e}$$

Then, the 'new' material properties E^* and ρ^* can be plotted onto the E - ρ chart to guide the material selection, as shown in Figure S4.

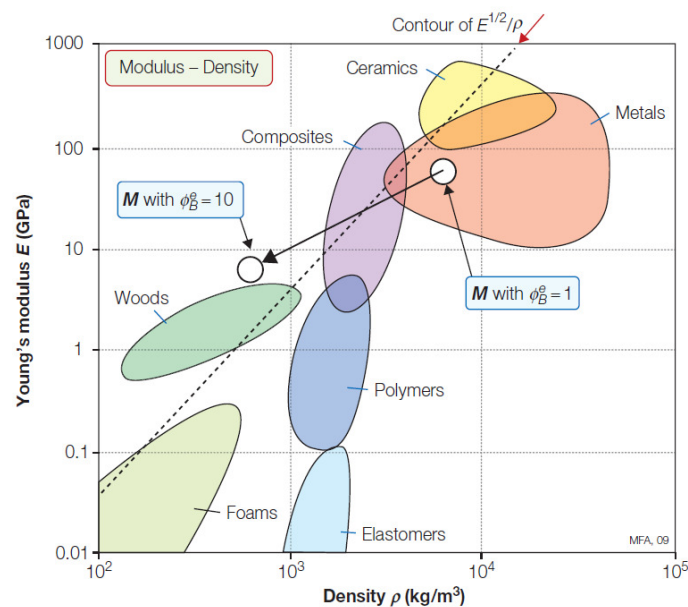

Figure S4 The structured material behaves like a new material with a modulus E^* and a density ρ^* , moving it from below the broken selection line to above it.

For bending strength, a similar procedure can be applied at minimum weight. The Material index for failure in bending can be re-written as:

$$M_2 = \frac{(\phi_B^f \sigma_f)^{\frac{2}{3}}}{\rho} = \frac{(\sigma_f / (\phi_B^f)^2)^{\frac{2}{3}}}{\rho / (\phi_B^f)^2} = \frac{\sigma_f^{*2/3}}{\rho^*}$$

The material with strength σ_f and density ρ , when shaped, behaves in bending like a new material of strength and density:

$$\sigma_f^* = \frac{\sigma_f}{(\phi_B^f)^2} \text{ and } \rho^* = \frac{\rho}{(\phi_B^f)^2}$$

Similarly, the ‘new’ material properties σ_f^* and ρ^* can be plotted onto the σ_f - ρ chart, as presented in Figure S5.

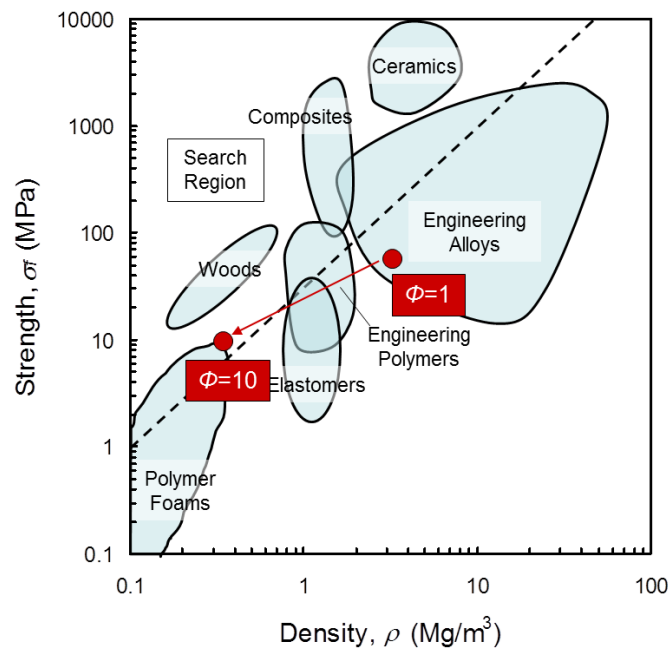

Figure S5 The structured material behaves like a new material with a strength σ_f^* and a density ρ^* .

Reference:

Michael F. Ashby, *Materials selection in mechanical design*, 5th Edition, Chapter 10: *Section of Materials and Shape*, Elsevier Ltd, Oxford, 2017.