

MMME2046 Dynamics: Control Lecture 4

Position Control Systems

(case studies in 1st & 2nd order systems)

Lecture Objectives:

- Introduce the differences between 1st and 2nd order systems
- Analyse steady-state responses under step and ramp inputs
- Analyse transient behaviour through the roots of the characteristic equations

Recap: Hydraulic Position Control System

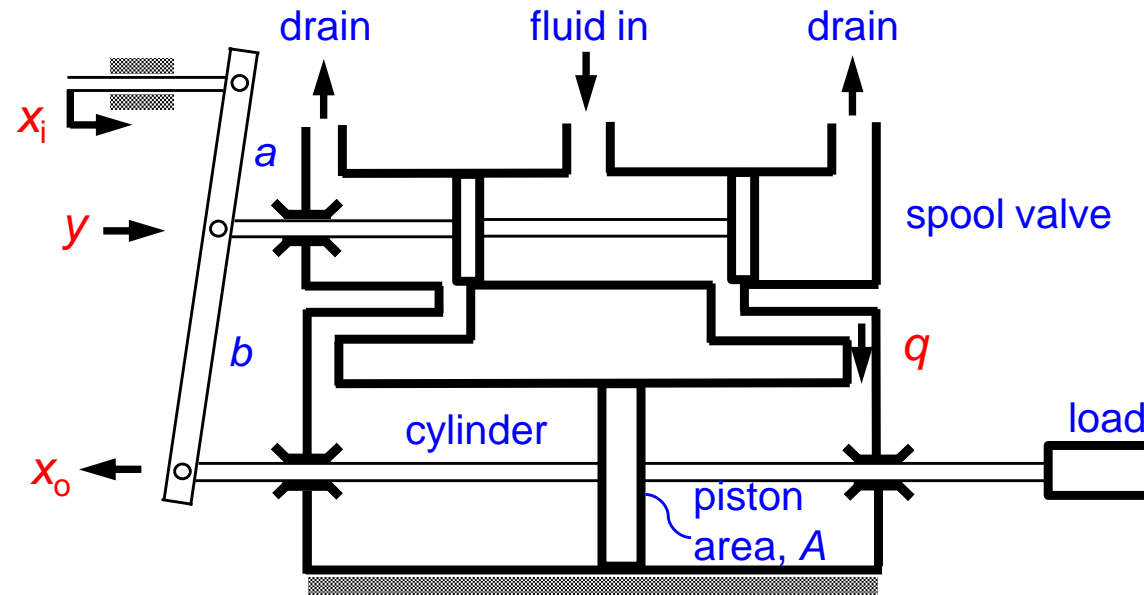

It was shown that the **transfer function** is given by

$$G(s) = \frac{X_o(s)}{X_i(s)} = \frac{\mu}{1 + Ts} \quad \text{1st order system}$$

with the **block diagram**

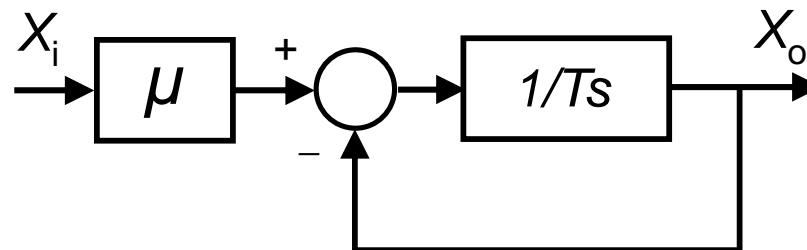

Hydraulic Position Control System: Equations for the Model

Spool Valve

in the time domain

$$q = Ky$$

transfer function

$$\frac{Q(s)}{Y(s)} = K \quad (1)$$

Ram Piston

in the time domain

$$A \frac{dx_o}{dt} = q$$

transfer function

$$\frac{X_o(s)}{Q(s)} = \frac{1}{As} \quad (2)$$

Feedback Link

in the time domain

$$y = \frac{b}{a+b} x_i - \frac{a}{a+b} x_o$$

transfer function

$$Y(s) = \frac{b}{a+b} X_i(s) - \frac{a}{a+b} X_o(s) \quad (3)$$

Hydraulic Position Control System: Overall Transfer Function

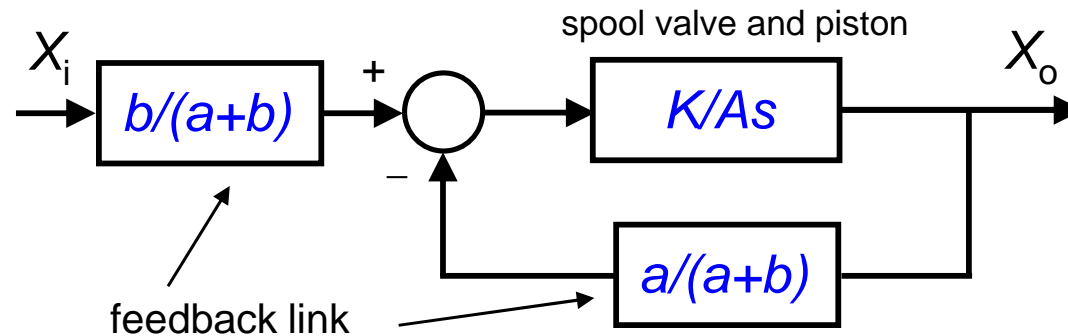

From the block diagram

$$X_o(s) = \left[X_i(s) \frac{b}{a+b} - X_o(s) \frac{a}{a+b} \right] \frac{K}{As}$$

rearranging

$$\left[1 + \frac{A(a+b)s}{Ka} \right] X_o(s) = \frac{b}{a} X_i(s)$$

$$\frac{X_o(s)}{X_i(s)} = \frac{\mu}{1 + Ts} \quad (4)$$

First order system with time constant T and gain μ

Hydraulic Position Control System: Control System Model

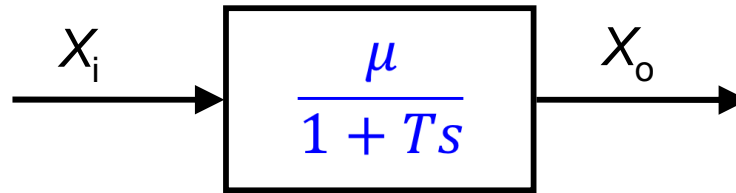

$$T = \frac{A(a + b)}{Ka} \quad \text{time constant}$$

$$\mu = \frac{b}{a} \quad \text{steady-state gain}$$

Hydraulic Position Control System under Standard Inputs

i) step Input

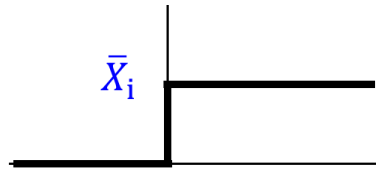

$$\begin{aligned} t < 0 & \quad x_i(t) = 0 \\ t \geq 0 & \quad x_i(t) = \bar{X}_i \end{aligned}$$

From the table of L.T.

$$X_i(s) = \frac{\bar{X}_i}{s} \quad (5)$$

The output in s-domain

$$X_o(s) = \frac{\mu \bar{X}_i}{s(1 + Ts)} \quad (6)$$

In the time domain

$$x_o(t) = \mu \bar{X}_i \left(1 - e^{-\frac{t}{T}} \right) \quad (7)$$

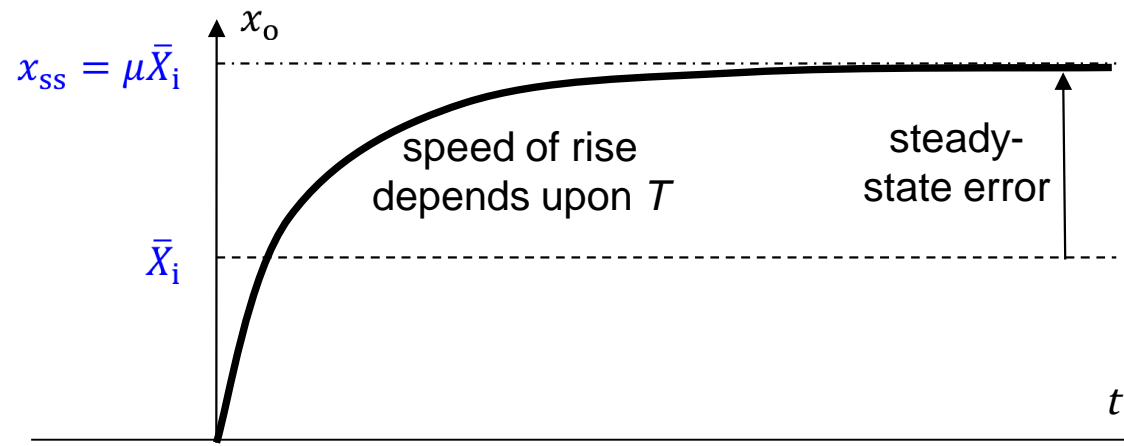

Hydraulic Position Control System under Standard Inputs

ii) Ramp Input

$$\begin{aligned} t < 0 & \quad x_i(t) = 0 \\ t \geq 0 & \quad x_i(t) = \bar{V}_i t \end{aligned}$$

From the table of L.T.

$$X_i(s) = \frac{\bar{V}_i}{s^2}$$

The output in s-domain

$$X_o(s) = \frac{\mu \bar{V}_i}{s^2(1 + Ts)}$$

In the time domain

$$x_o(t) = \mu \bar{V}_i t - \mu \bar{V}_i T \left(1 - e^{-t/T}\right)$$

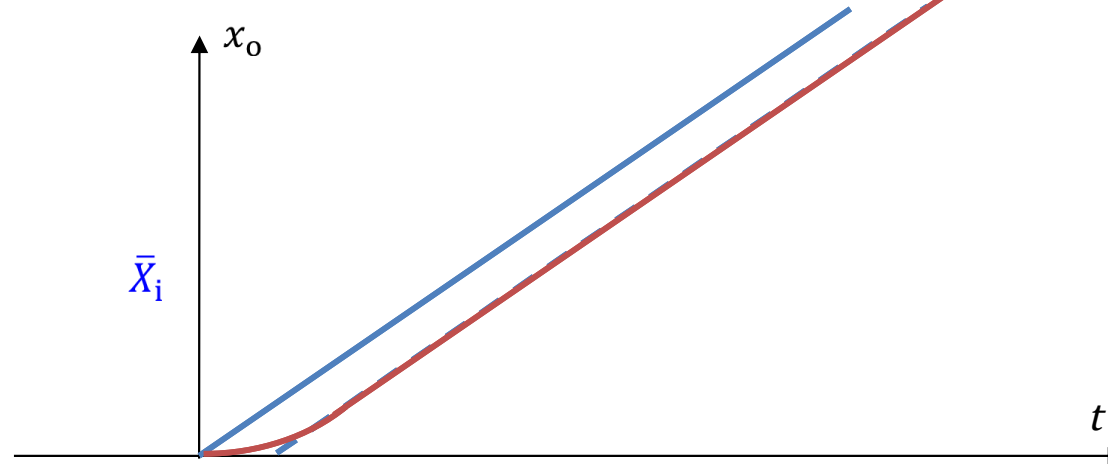

Hydraulic Position Control System under Standard Inputs

iii) Oscillatory

input

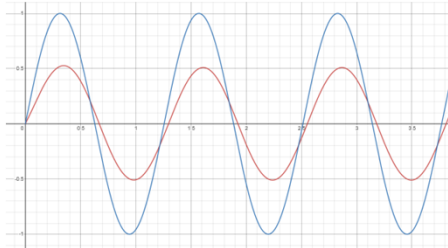

$$\begin{aligned}
 t < 0 & \quad x_i(t) = 0 \\
 t \geq 0 & \quad x_i(t) = A \sin(\omega t)
 \end{aligned}$$

From the table of L.T.

$$X_i(s) = \frac{A\omega^2}{(s^2 + \omega^2)} \tag{5}$$

The output in s-domain

$$X_o(s) = \frac{\mu A \omega^2}{(s^2 + \omega^2)(1 + Ts)} \tag{6}$$

$$X_{out}(s) = \frac{\mu A \omega^2}{1 + \omega^2 T^2} \left(\frac{1 - Ts}{(s^2 + \omega^2)} + \frac{T^2}{(1 + Ts)} \right) = \frac{\mu A \omega^2}{1 + \omega^2 T^2} \left(\frac{1}{(s^2 + \omega^2)} - \frac{Ts}{(s^2 + \omega^2)} + \frac{T^2}{(1 + Ts)} \right)$$

**Steady state:
gain and phase
angle (1st order lag)**

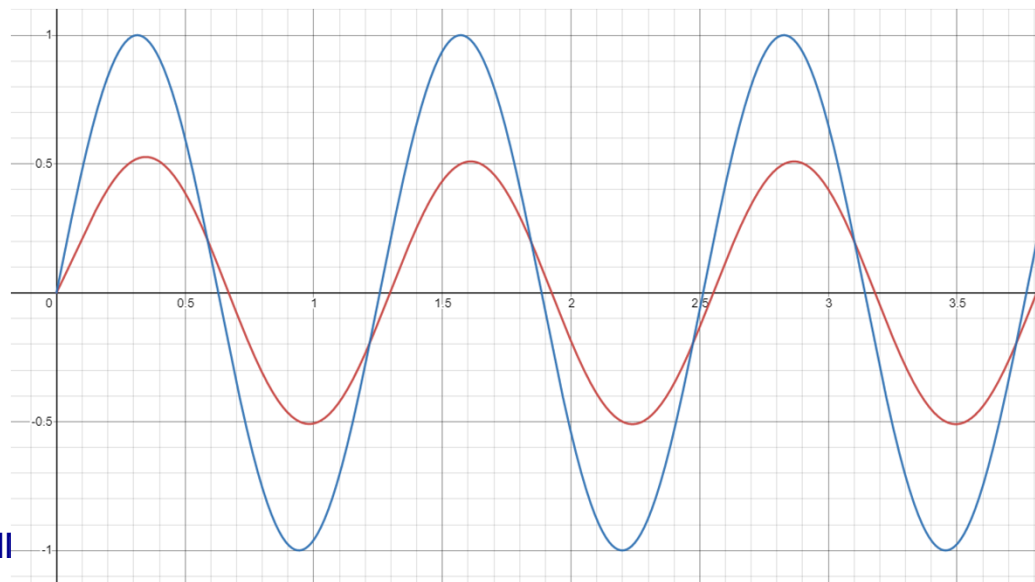

Hydraulic Position Control System under Standard Inputs

iii) Oscillatory

input

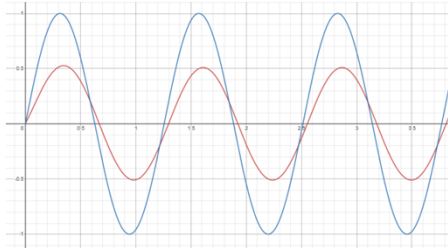

$$\begin{aligned}
 t < 0 & \quad x_i(t) = 0 \\
 t \geq 0 & \quad x_i(t) = A \sin(\omega t)
 \end{aligned}$$

From the table of L.T.

$$X_i(s) = \frac{A\omega^2}{(s^2 + \omega^2)} \tag{5}$$

The output in s-domain

$$X_o(s) = \frac{\mu A \omega^2}{(s^2 + \omega^2)(1 + Ts)} \tag{6}$$

$$X_{out}(s) = \frac{\mu A \omega^2}{1 + \omega^2 T^2} \left(\frac{1 - Ts}{(s^2 + \omega^2)} + \frac{T^2}{(1 + Ts)} \right) = \frac{\mu A \omega^2}{1 + \omega^2 T^2} \left(\frac{1}{(s^2 + \omega^2)} - \frac{Ts}{(s^2 + \omega^2)} + \frac{T^2}{(1 + Ts)} \right)$$

**Steady state:
gain and phase
angle (1st order lag)**

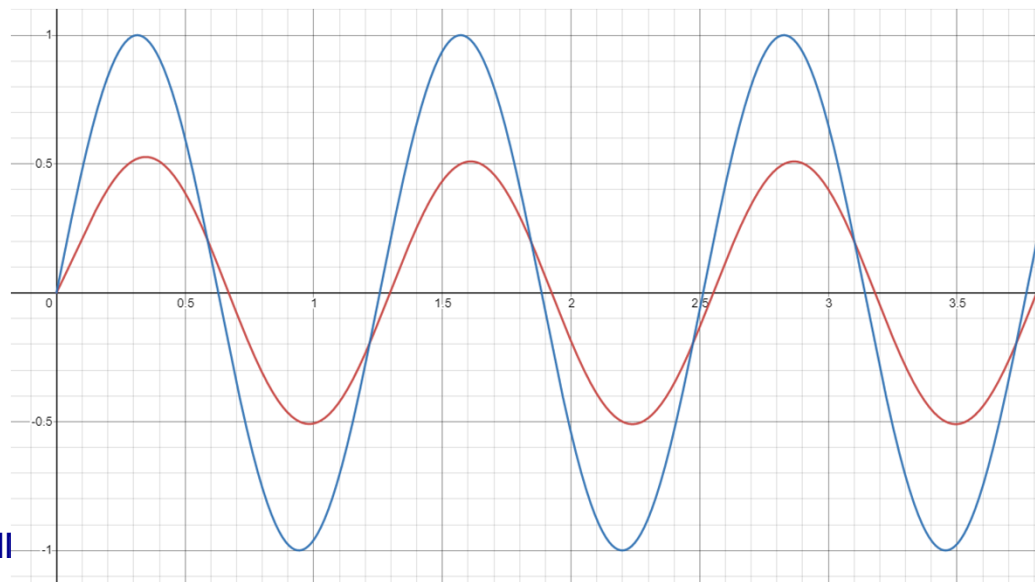

Recap: The Final Value Theorem

The final value theorem:

$$x_{ss} = \lim_{t \rightarrow \infty} x_o(t) = \lim_{s \rightarrow 0} sX_o(s) \quad (9)$$

Gives the steady-state response of a system.

Some provisos:

Steady state implies that we have a finite end value:

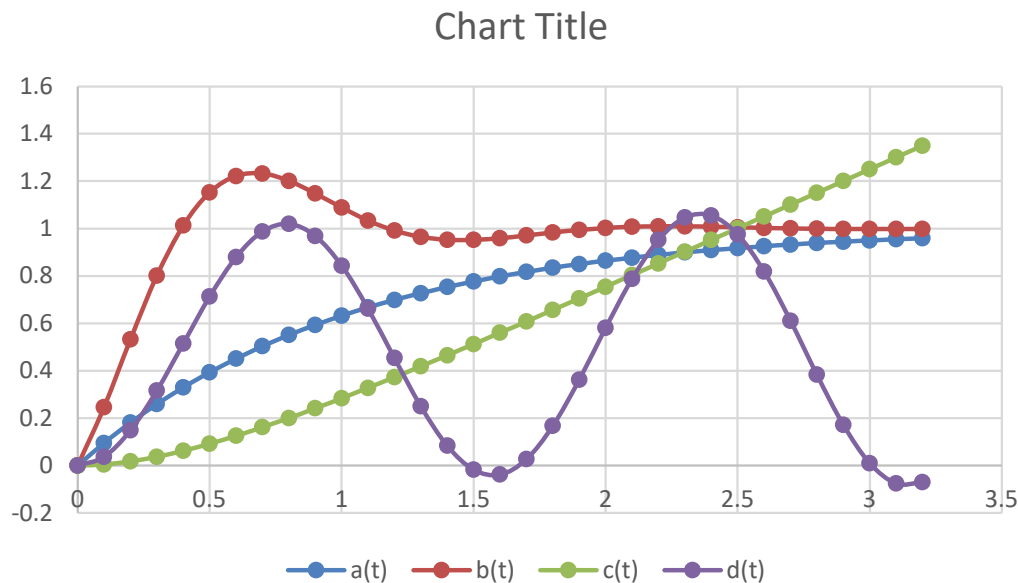

Which of these can we use the finite value theorem on?

a(t)?

b(t)?

c(t)?

d(t)?

Hydraulic Position Control System: The Final Value Theorem

The **final value theorem** gives the **steady-state response**

$$x_{ss} = \lim_{t \rightarrow \infty} x_o(t) = \lim_{s \rightarrow 0} sX_o(s) \quad (9)$$

$$x_{ss} = \lim_{s \rightarrow 0} s \frac{\mu \bar{X}_i}{s(1 + Ts)} = \mu \bar{X}_i \quad (10)$$

The **steady-state error** from the **final value theorem**

$$E(s) = X_i(s) - X_o(s)$$

$$e_{ss} = \lim_{s \rightarrow 0} s \frac{(1 + Ts - \mu) \bar{X}_i}{(1 + Ts)} \frac{1}{s} = \lim_{s \rightarrow 0} \frac{(1 + Ts - \mu)}{(1 + Ts)} \bar{X}_i = (1 - \mu) \bar{X}_i \quad (13)$$

Exercise: Show that if the error is defined as

$$e_{\text{new}} = \mu x_i - x_o$$

the steady-state error is zero

$$e_{\text{new}_{ss}} = 0$$

Hydraulic Position Control System: Transient Response

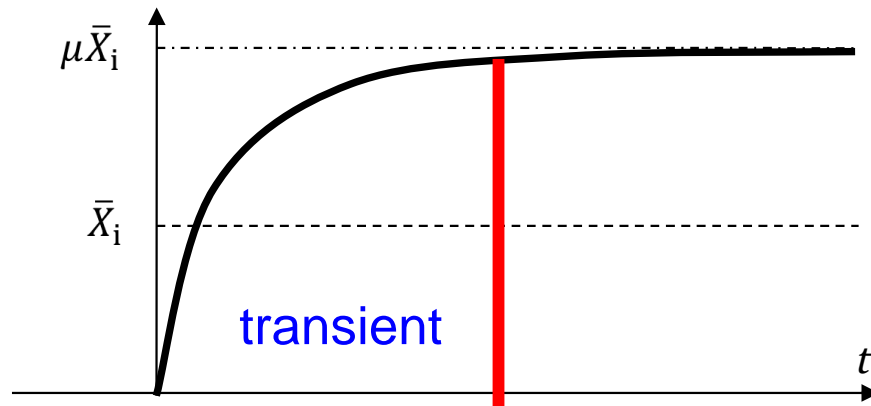

characteristic equation

Set denominator = 0

$$P(s) = s + \frac{1}{T} = 0$$

with one real root $s = -\frac{1}{T}$

The **roots of the C.E.** in the **s-plane** govern stability and transient behaviour

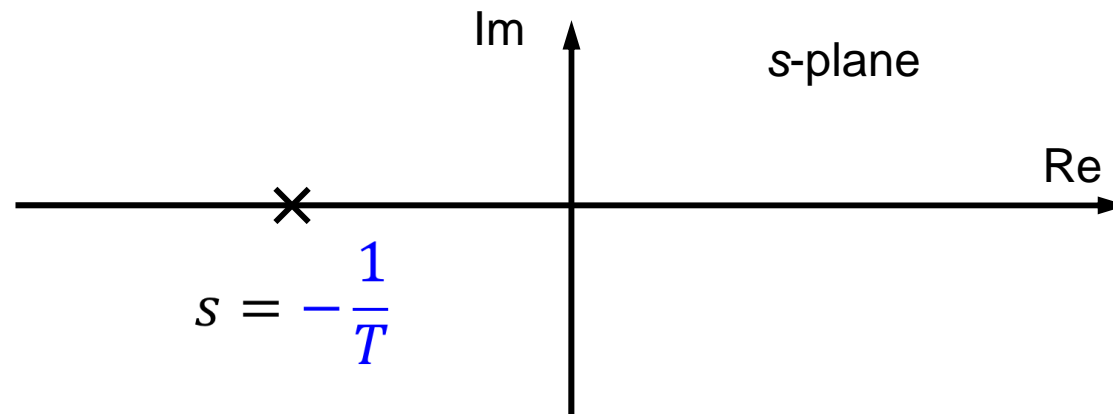

Hydraulic Position Control System under Standard Inputs

ii) ramp Input

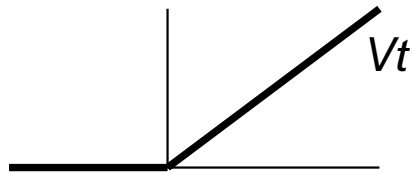

$$\begin{aligned} t < 0 & \quad x_i(t) = 0 \\ t \geq 0 & \quad x_i(t) = Vt \end{aligned}$$

From the table of L.T. $X_i(s) = \frac{V}{s^2}$ (14)

The output in s-domain $X_o(s) = \frac{\mu V}{s^2(1 + Ts)}$ (15)

In the time domain $x_o(t) = \mu Vt - \mu VT \left(1 - e^{-\frac{t}{T}}\right)$ (16)

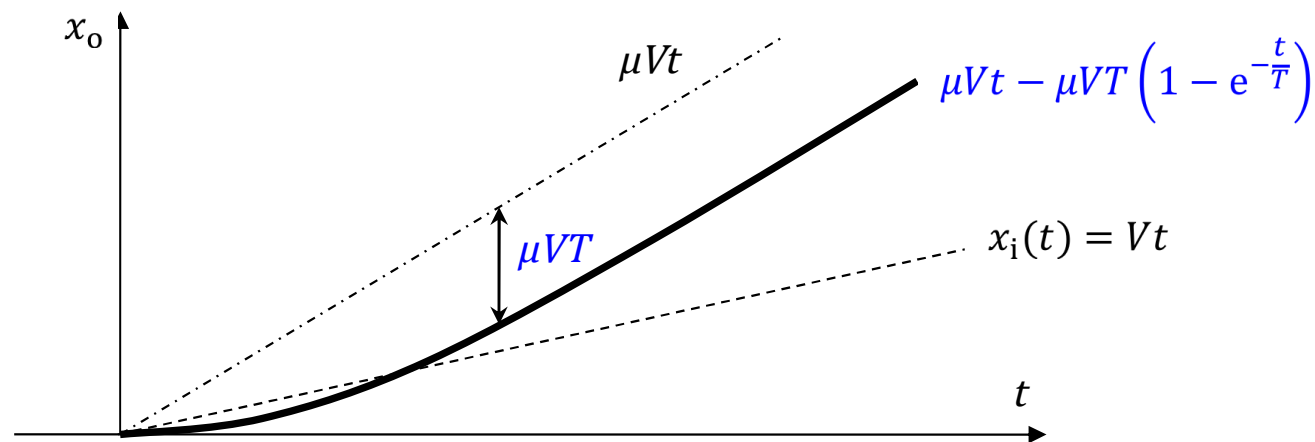

Simulink model

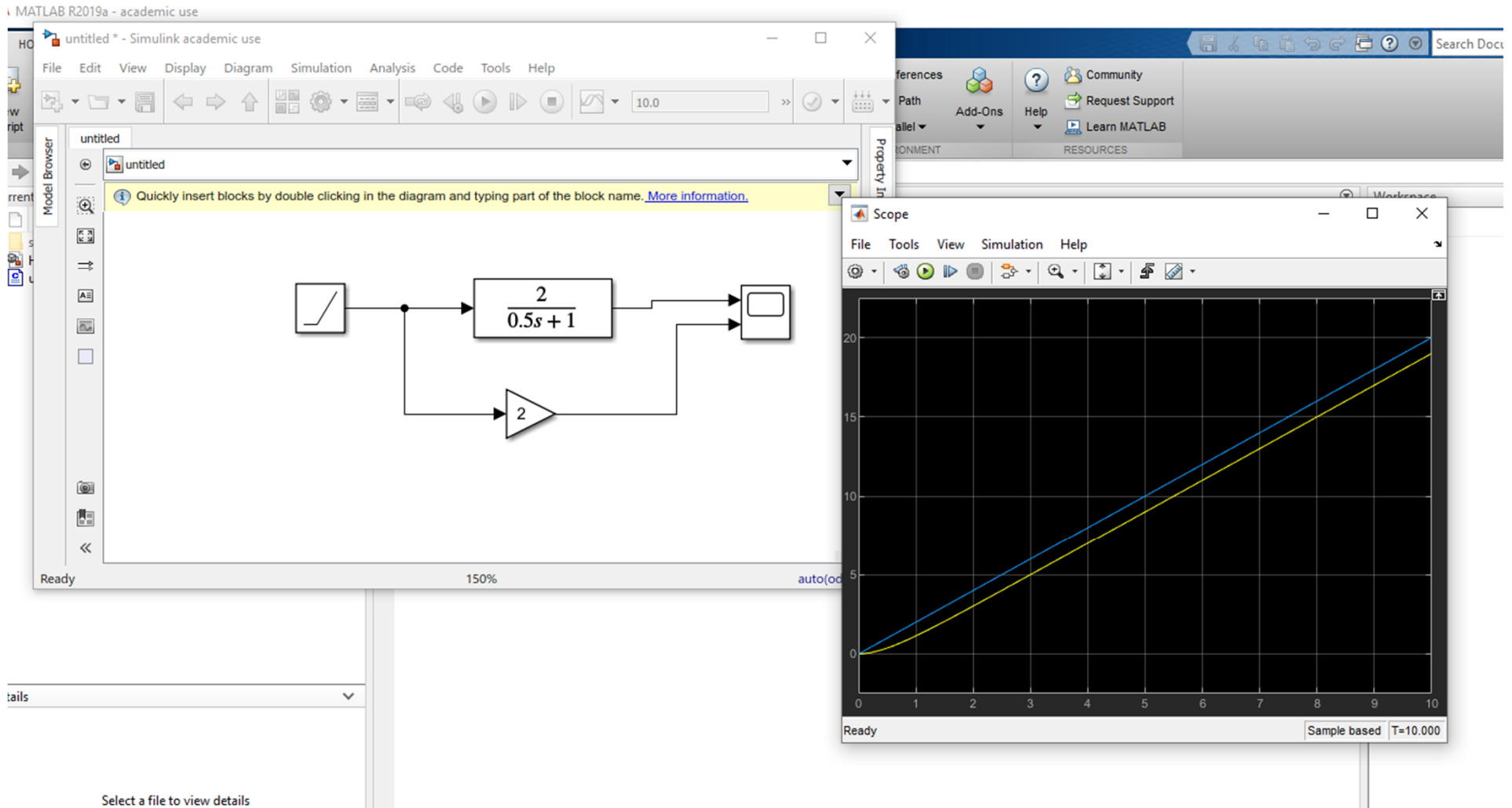

Other types of Steady State Error

Ramp output: Velocity lag

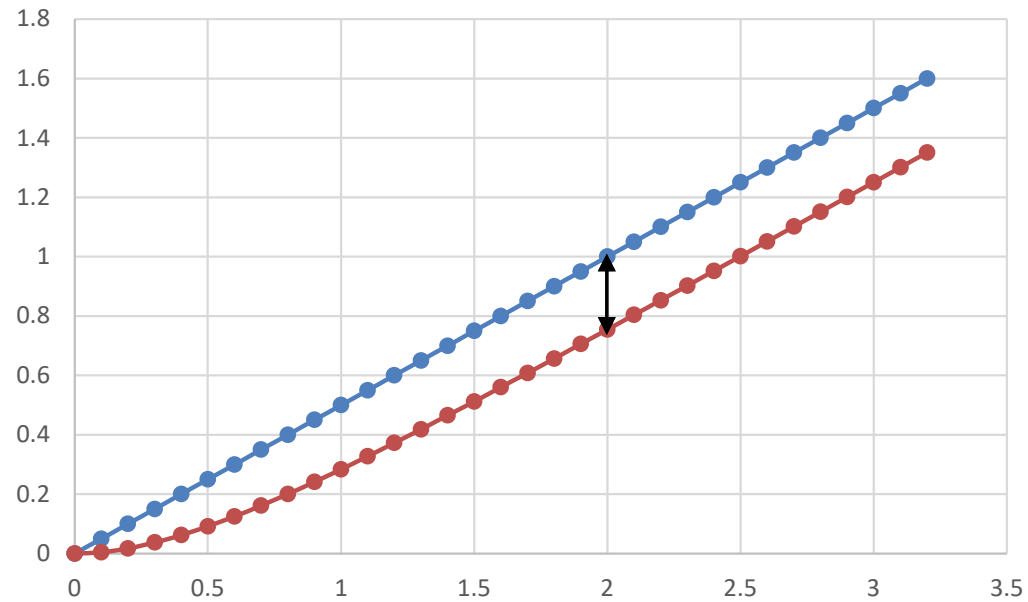

Oscillating output: phase lag
(not in scope!)

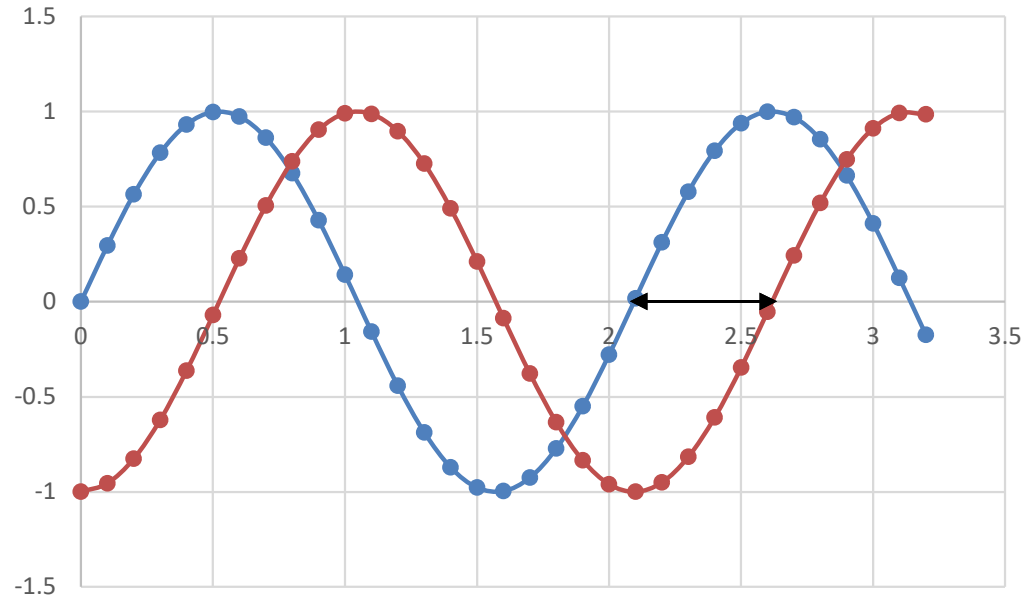

Hydraulic Position Control System: S.-S. Error under Ramp Input

After a “large” time interval ($t > 4T$) $e^{-t/T} \rightarrow 0$

$$x_{ss}(t) = \mu V(t - T)$$

Define the error as

$$E(s) = \mu X_i(s) - X_o(s)$$

$$e_{ss} = \lim_{s \rightarrow 0} s \left(\mu - \frac{\mu}{1 + Ts} \right) X_i(s) = \lim_{s \rightarrow 0} s \left(\frac{\mu s T}{1 + Ts} \right) X_i(s)$$

$$e_{ss} = \lim_{s \rightarrow 0} s \frac{\mu s T}{(1 + Ts)} \frac{V}{s^2} = \mu VT$$

non-zero **finite** steady-state error called “velocity lag”

Example: Electro-Mechanical Position Control System

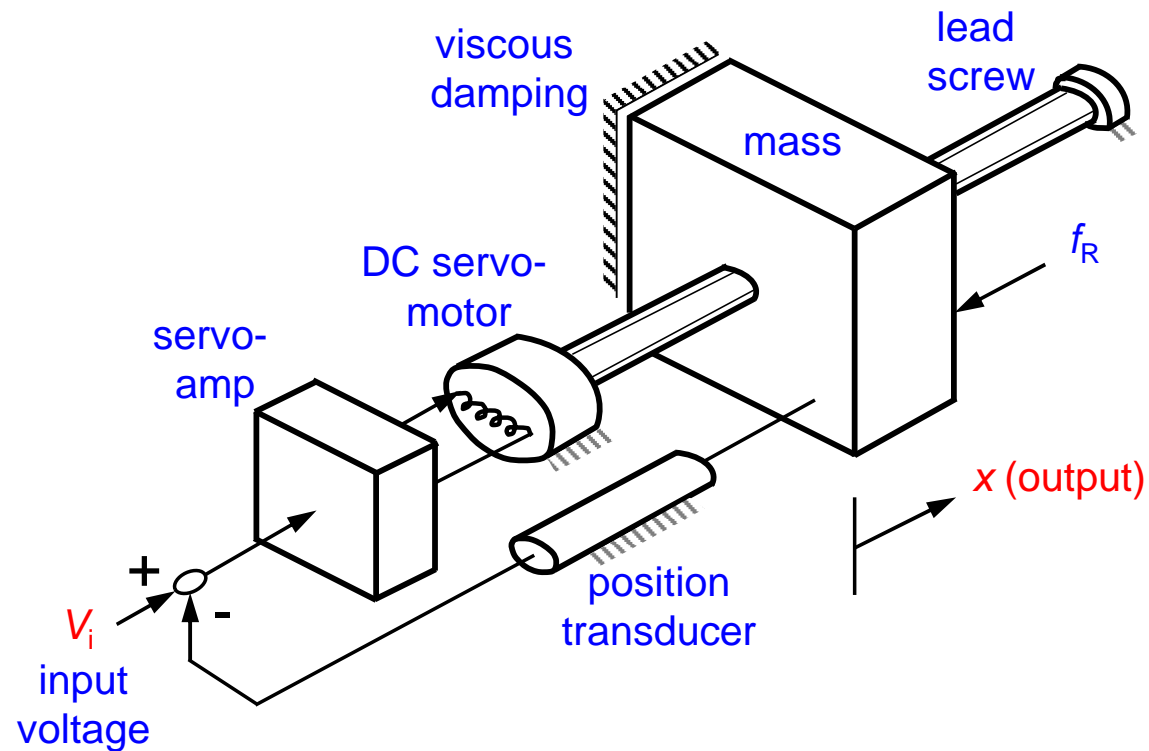

It will be shown that the **transfer functions** may be written as

$$\frac{X(s)}{X_i(s)} = \frac{\omega_n^2}{s^2 + 2\gamma\omega_n s + \omega_n^2}$$

$$\frac{X(s)}{F_R(s)} = \frac{-1}{M(s^2 + 2\gamma\omega_n s + \omega_n^2)}$$

2nd order system

<https://www.youtube.com/watch?v=Sn8DqDGwazs>

E.-M. Position Control System: Equations for the Model

i) **Position Transducer** output $V_x = K_4 x$ K_4 is constant
error voltage $V_e = V_i - V_x = V_i - K_4 x$

ii) **Servo-Amplifier** develops current (K_1 is another constant)

$$i_f = K_1 V_e = K_1 (V_i - K_4 x)$$

iii) **DC Servo-Motor** develops torque (K_2 is motor constant)

$$l_m = K_2 i_f = K_2 K_1 (V_i - K_4 x)$$

iv) At **Lead Screw** the torque is converted into a force on the load mass

$$f_m = K_3 l_m = K_3 K_2 K_1 (V_i - K_4 x) \quad K_3 = 2\pi / (\text{pitch of leadscrew})$$

Laplace domain $F_m(s) = K_1 K_2 K_3 (V_i(s) - K_4 X(s))$ (1)

v) For the **Load Mass** assuming viscous damping

$$M\ddot{x} + C\dot{x} = f_m - f_R$$

Laplace domain $X(s) = \frac{F_m(s) - F_R(s)}{Ms^2 + Cs}$ (2)

E.-M. Position Control System: Block Diagrams

Using Eqs. (1) and (2)

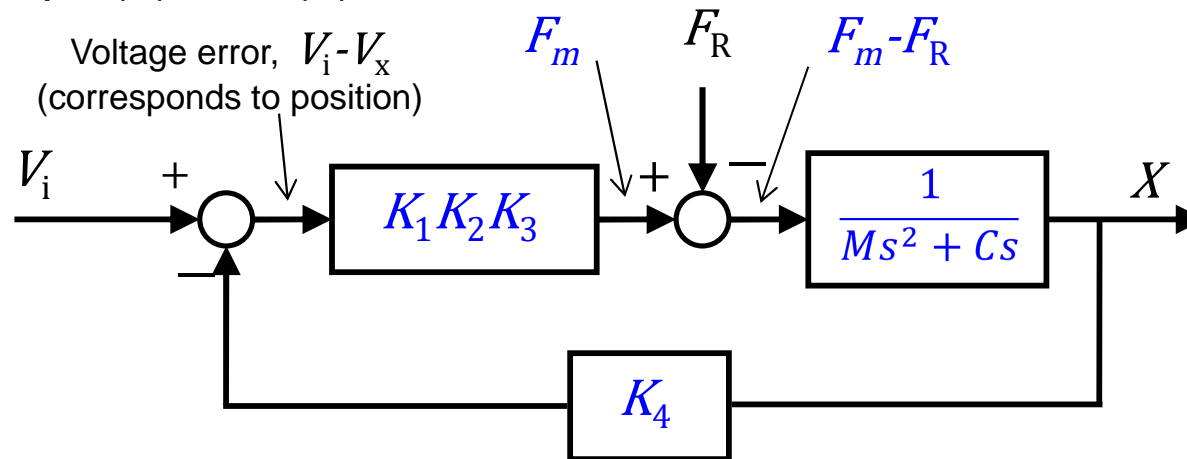

Focusing on actual position error

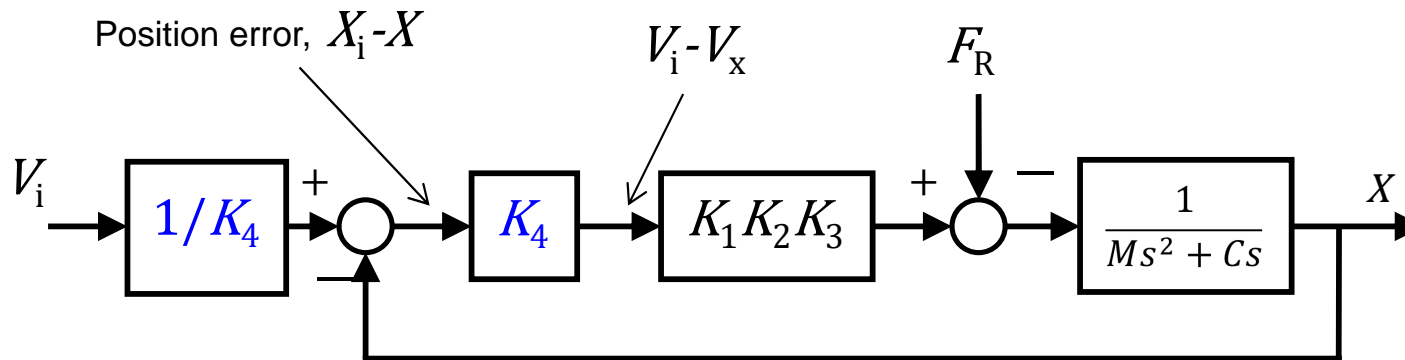

with $K = K_1 K_2 K_3 K_4$

$$X(s) = ([X_i(s) - X(s)]K - F_R(s)) \frac{1}{Ms^2 + Cs}$$

E-.M. Position Control System: Overall Transfer Function

Rearranging $[Ms^2 + Cs + K]X(s) = KX_i(s) - F_R(s)$ (3)

Preferred form

$$[s^2 + 2\gamma\omega_n s + \omega_n^2]X(s) = \omega_n^2 X_i(s) - \frac{F_R(s)}{M}$$

with $\frac{C}{M} = 2\gamma\omega_n$ and $\omega_n^2 = \frac{K}{M}$

$$X(s) = \frac{\omega_n^2 X_i(s)}{s^2 + 2\gamma\omega_n s + \omega_n^2} - \frac{F_R(s)}{M(s^2 + 2\gamma\omega_n s + \omega_n^2)}$$

Transfer function

$$\frac{X(s)}{X_i(s)} = \frac{\omega_n^2}{s^2 + 2\gamma\omega_n s + \omega_n^2} \quad (4)$$

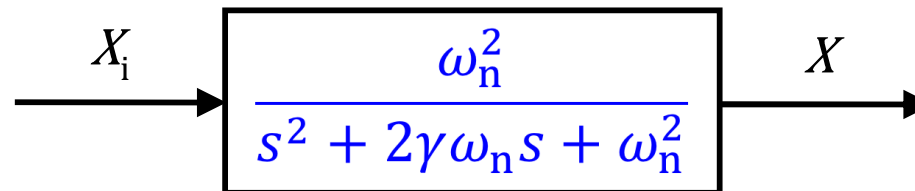

E.-M. Position Control System under Standard Inputs

i) step Input

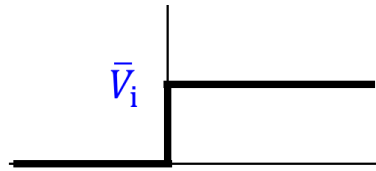

$$\begin{aligned} t < 0 & \quad V_i(t) = 0 \\ t \geq 0 & \quad V_i(t) = \bar{V}_i \end{aligned}$$

From the table of L.T.
$$X_i(s) = \frac{\bar{V}_i}{K_4 s} = \frac{\bar{X}_i}{s} \quad (5)$$

The output in s-domain

$$X_o(s) = \frac{\omega_n^2 \bar{X}_i}{s(s^2 + 2\gamma\omega_n s + \omega_n^2)} = \frac{\omega_n^2 \bar{X}_i}{s(s - p_1)(s - p_2)} \quad (6)$$

with the roots of the characteristic equation

$$s^2 + 2\gamma\omega_n s + \omega_n^2 = 0$$

$$p_1 = -\gamma\omega_n + \omega_n\sqrt{\gamma^2 - 1} \quad p_2 = -\gamma\omega_n - \omega_n\sqrt{\gamma^2 - 1}$$

E.-M. Position Control System under Step Input

Assuming a *unit step input* and using partial fractions

$$X_o(s) = \frac{B}{s} + \frac{A_1}{s - p_1} + \frac{A_2}{s - p_2}$$

where (for $\gamma \neq 1$)

$$B = 1; \quad A_1 = -\frac{1}{2} - \frac{\gamma}{2\sqrt{\gamma^2 - 1}}; \quad A_2 = -\frac{1}{2} + \frac{\gamma}{2\sqrt{\gamma^2 - 1}}$$

With the inverse Laplace transform, in the time domain

$$x_o(t) = B + A_1 e^{p_1 t} + A_2 e^{p_2 t} \quad (7)$$

This solution, valid for $\gamma \neq 1$, gives rise to two distinct types of transient response.

E.-M. Position Control System under Step Input

i) $\gamma > 1$ p_1 and p_2 are **real** and **unequal**. For this situation the response is overdamped (non-oscillatory).

ii) $\gamma < 1$ p_1 and p_2 are **complex conjugate** (as A_1 and A_2)

$$p_1 = -\gamma\omega_n + i\omega_n\sqrt{1-\gamma^2}$$

$$p_2 = -\gamma\omega_n - i\omega_n\sqrt{1-\gamma^2}$$

$$x_o(t) = \bar{X}_i \left[1 - \frac{e^{-\gamma\omega_n t}}{\sqrt{1-\gamma^2}} \sin(\omega_n t \sqrt{1-\gamma^2} + \phi) \right]$$

Maximum overshoot at $t = \frac{\pi}{\omega_n \sqrt{1-\gamma^2}}$

with magnitude $x_{\max} = \bar{X}_i \left(1 + e^{\frac{-\gamma\pi}{\sqrt{1-\gamma^2}}} \right)$

Simulink Model: $\gamma > 1$

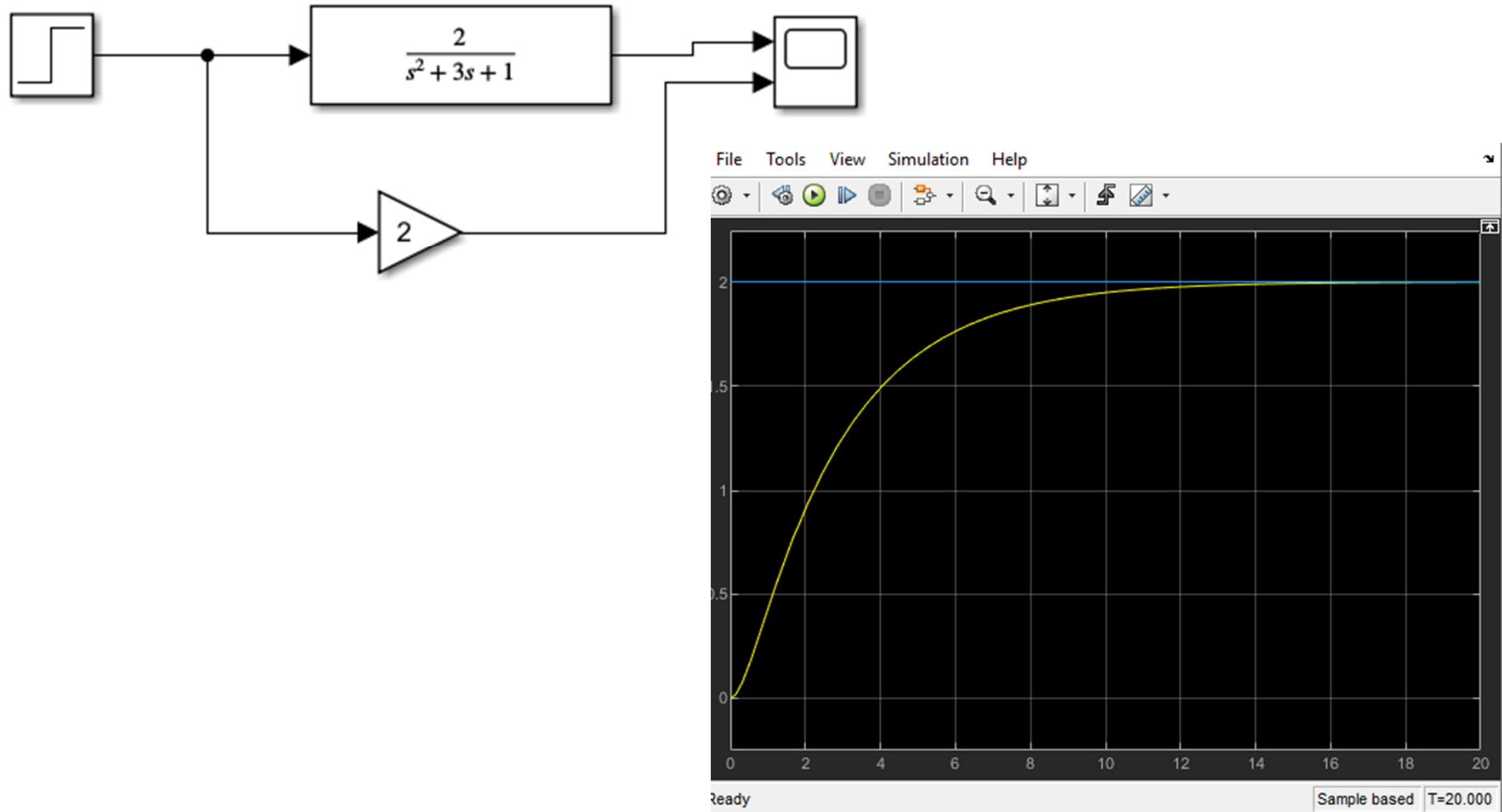

Simulink Model: $\gamma < 1$

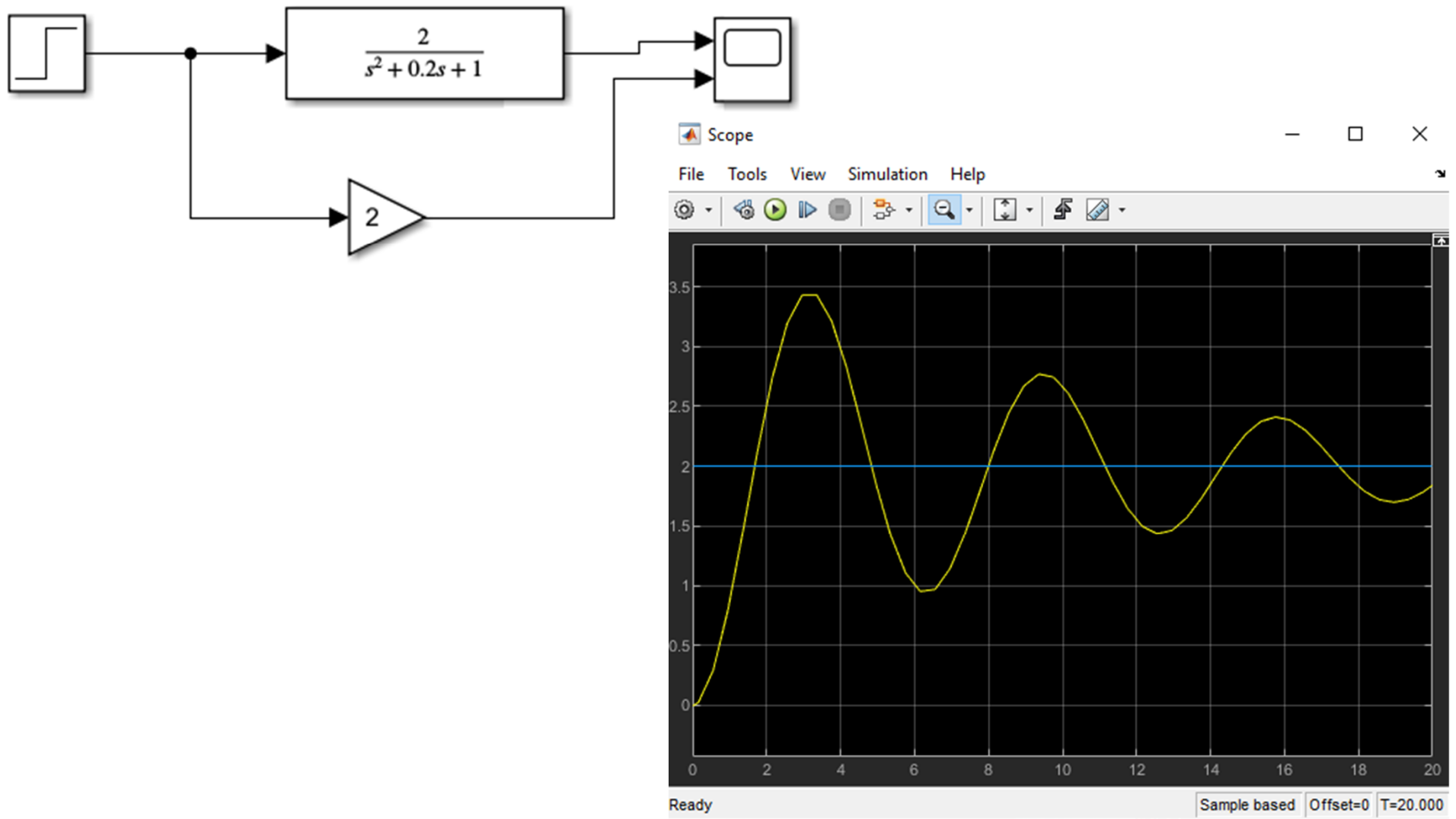

Simulink Model: $\gamma=1$

What is the transfer function in this case?

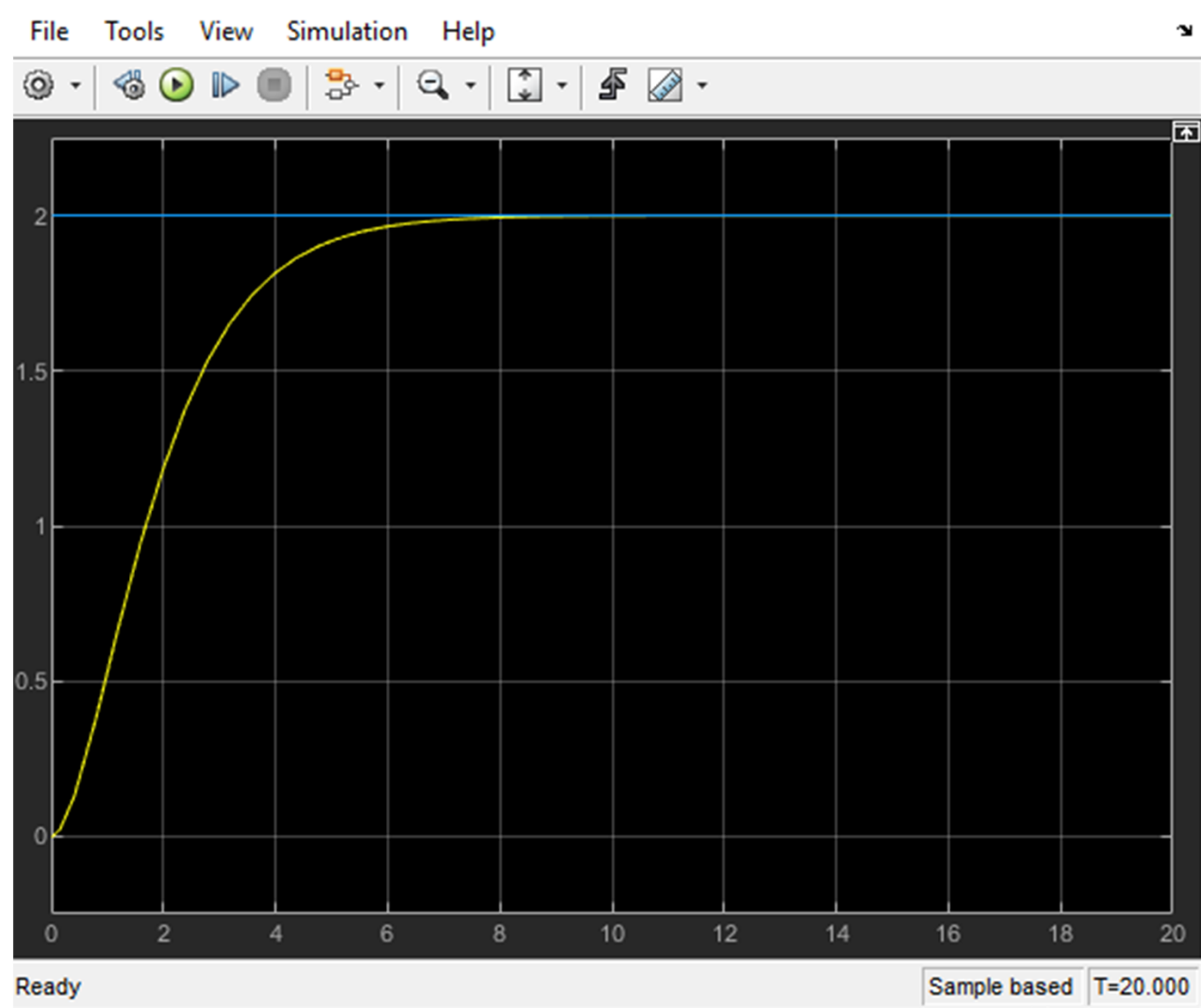

E.-M. Position Control System under Step Input

- iii) $\gamma = 1$ p_1 and p_2 are **real** and **equal** ($= -\omega_n$) and the response is
Is said to be critically damped.

$$x_o(t) = \bar{X}_i [1 - (1 + \omega_n t) e^{-\omega_n t}]$$

The transient responses under a step input for all three cases can be summarised

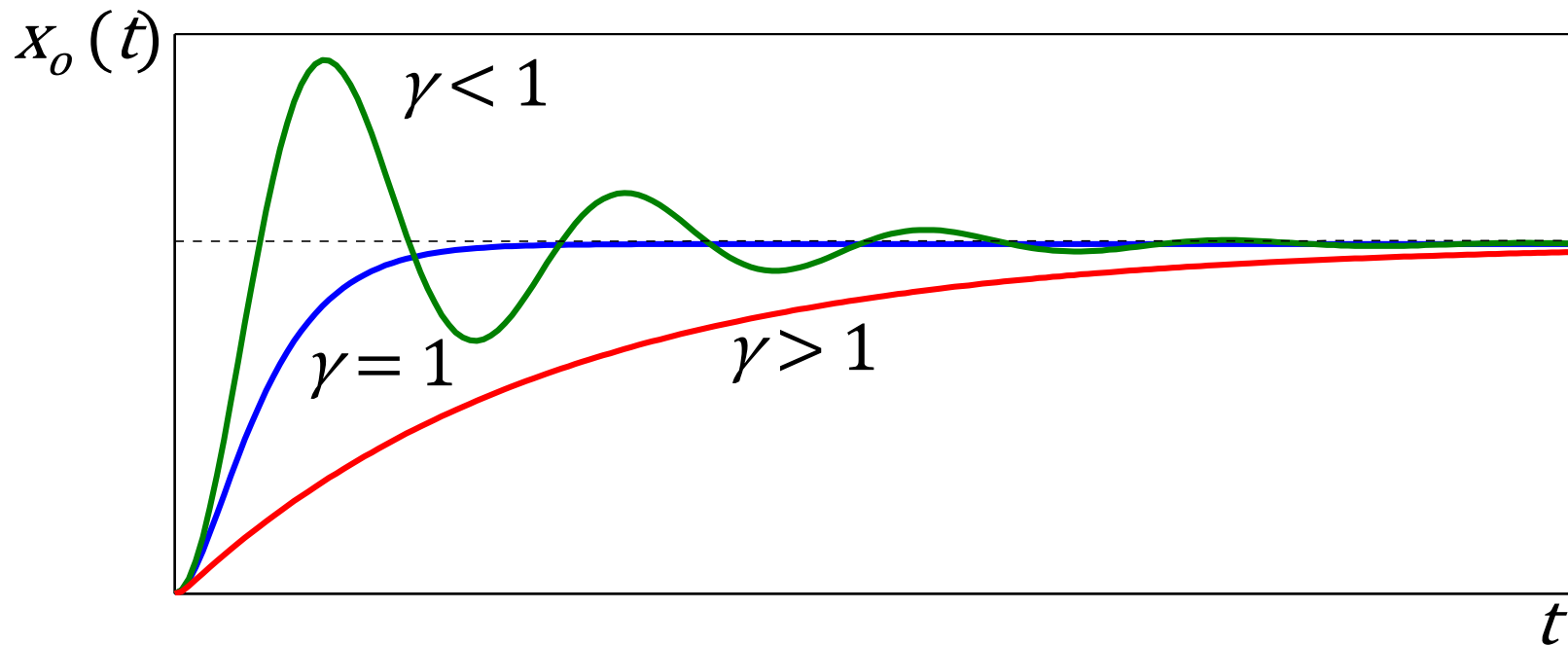

E.-M. Position Control System: Transient Response

The **roots of the C.E.** in the **s-plane** govern stability and transient behaviour

$$p_1 = -\gamma\omega_n + \omega_n\sqrt{\gamma^2 - 1}$$

$$p_2 = -\gamma\omega_n - \omega_n\sqrt{\gamma^2 - 1}$$

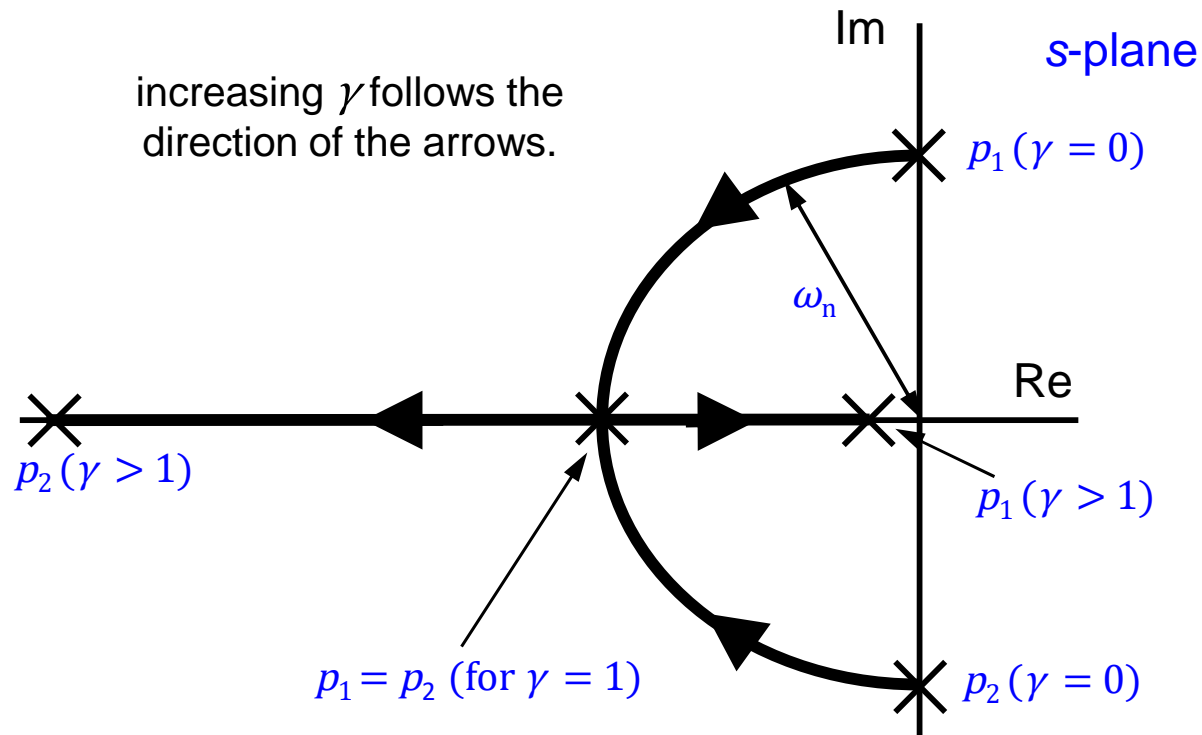

The roots trace out **loci** in the s-plane.

Visualisation of root locus

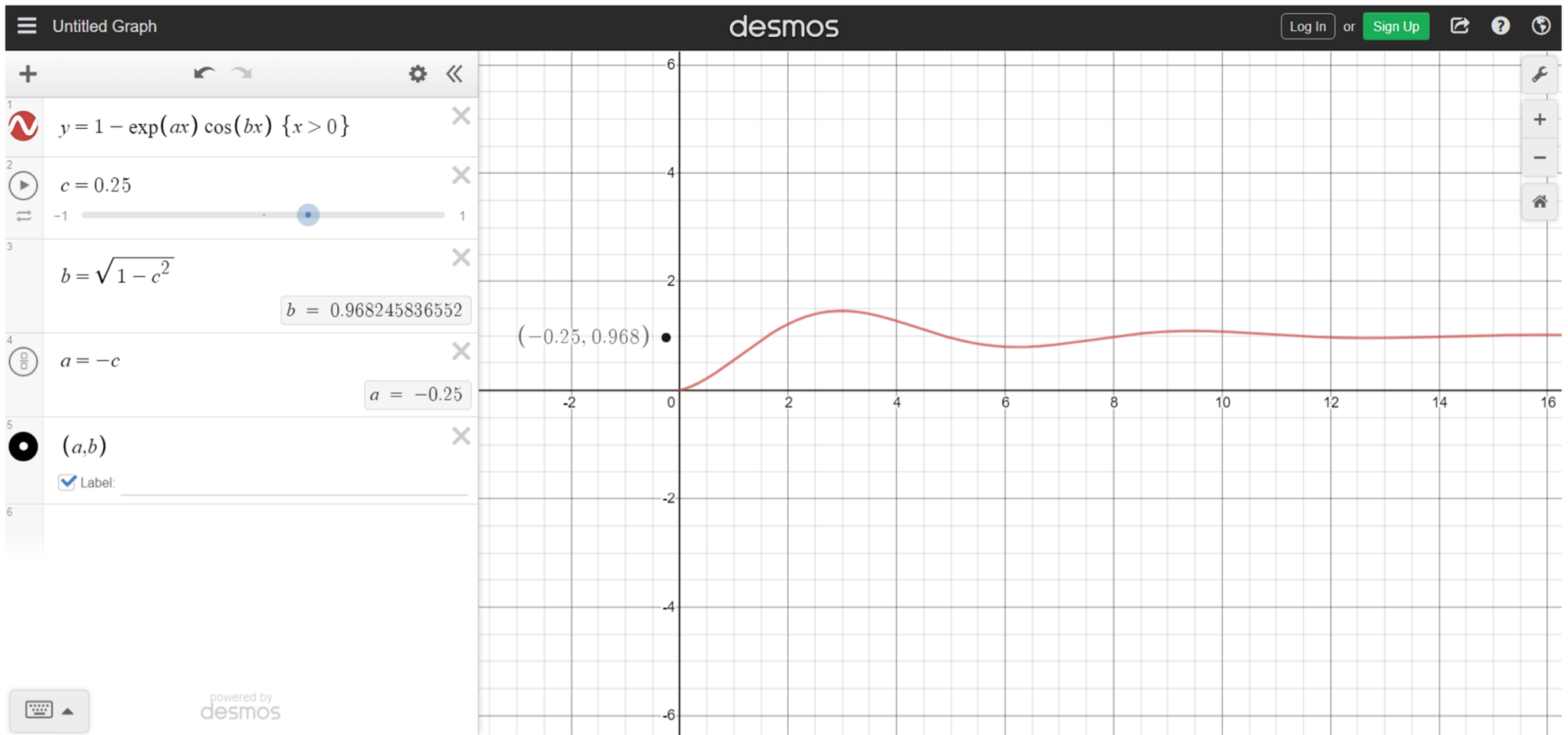

E.-M. Position Control System under Standard Inputs

ii) ramp Input

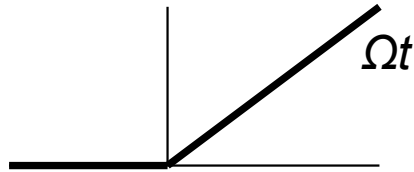

$$\begin{aligned} t < 0 & \quad V_i(t) = 0 \\ t \geq 0 & \quad V_i(t) = \Omega t \end{aligned}$$

From the table of L.T.

$$V_i(s) = \frac{\Omega}{s^2}$$

and from the b.d.

$$X_i(s) = \frac{V_i(s)}{K_4} = \frac{\Omega}{s^2 K_4} = \frac{\Omega_x}{s^2} \quad (8)$$

The output in s-domain

$$X_o(s) = \frac{\omega_n^2 \Omega_x}{s^2 (s^2 + 2\gamma\omega_n s + \omega_n^2)} \quad (9)$$

In the time domain

$$x_o(t) = \Omega_x \left(t - \frac{2\gamma}{\omega_n} + A_1 e^{p_1 t} + A_2 e^{p_2 t} \right) \quad (10)$$

Output $x_o(t)$

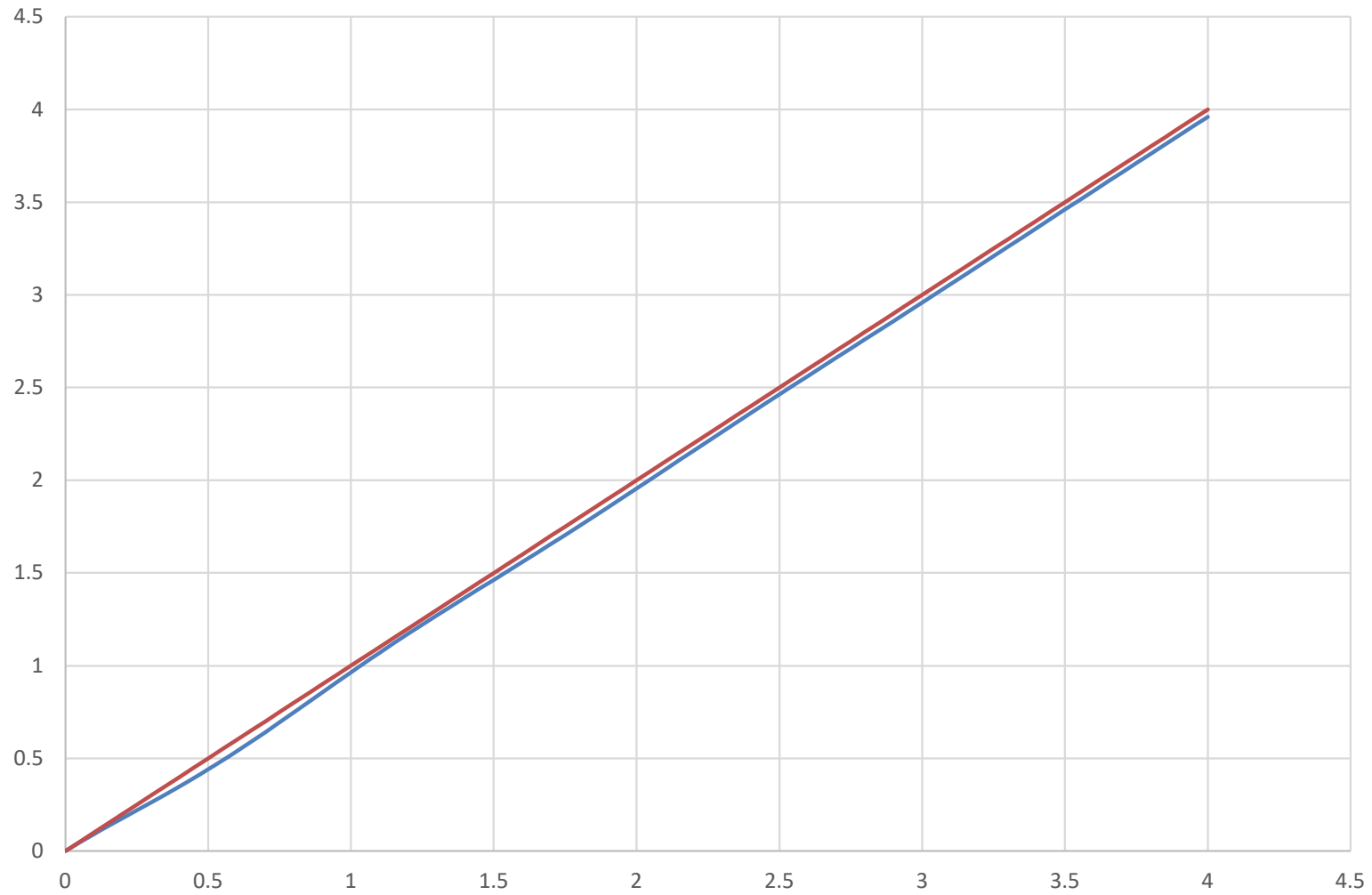

$e(t)$ for $\gamma < 1$

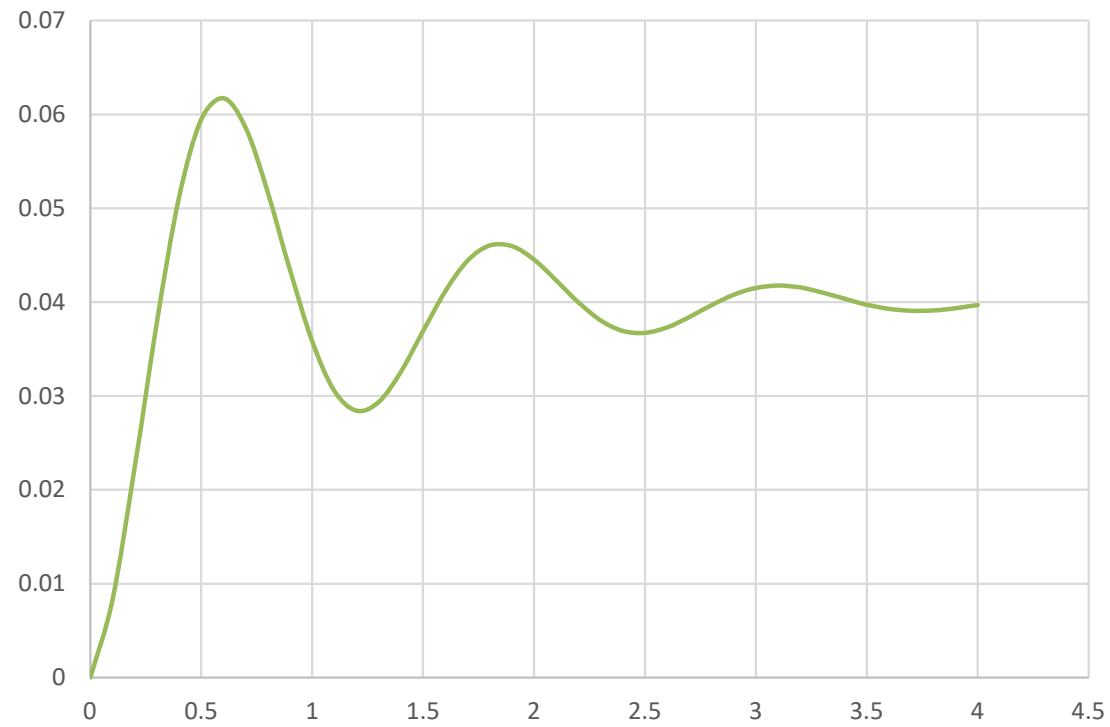

E.-M. Position Control System: S.-S. Error under Ramp Input

From the block diagram, for $F_R = 0$ (no disturbance)

$$E(s) = X_i(s) - X_o(s) = \frac{Ms^2 + Cs}{Ms^2 + Cs + K} X_i(s) \quad (11)$$

For a ramp input $X_i(s)$ from Eq. (8)

$$E(s) = \frac{Ms^2 + Cs}{Ms^2 + Cs + K} \frac{\Omega_x}{s^2} = \frac{Ms + C}{Ms^2 + Cs + K} \frac{\Omega_x}{s} \quad (12)$$

Using the **final value theorem** the steady-state error

$$\begin{aligned} e_{ss} &= \lim_{t \rightarrow \infty} e(t) = \lim_{s \rightarrow 0} sE(s) = \lim_{s \rightarrow 0} \frac{Ms + C}{Ms^2 + Cs + K} \Omega_x \\ &= \frac{C}{K} \Omega_x = \frac{2\gamma}{\omega_n} \Omega_x \end{aligned} \quad (13)$$

What Next?

- improving transient and steady-state performance: velocity feedback & PID control
- stability of feedback systems