

Lecture Notes: Design with Polymers

1. Introduction

In today's modern world, polymers are used in wide variety of applications such as food packaging, medical appliances, automotive components, electronics component and many more. In general, polymers have a modest specific strength (strength to weight ratio) compared to metals but the low cost and ease of processing into complex shapes makes polymers ubiquitous to modern society with wide applications industry, the home transport, packaging, distribution networks and so on. Polymers have other useful properties such as breakdown resistance and low conductivity, therefore, polymers are often a selected material for electronics and electrical application such as wiring, tools housing, circuit board, etc. Polymers can be corrosion resistant or degradable. Improved properties such as strength, abrasion resistance, toughness, thermal stability, stiffness, deterioration-ability, colour, and flammability resistance are achieved through additives and composite manufacture, see composites block. Some polymers also offer biocompatibility properties which makes them as one of the ideal materials for medical applications, such as finger implants, artificial joints, stents and sutures as well as medical equipment. Based on these properties, an engineer should understand about the structure, property range, characteristics, applications, and processing of polymeric materials to make informed selection choices. In this block we focus on the materials selection of polymers in design selection and use it to illustrate the complex interaction between structure-properties-processing-. (If this sparks your interest in polymers the you can select a module "Polymer Engineering" in your third or fourth year of studies where you can learn more detail about the principles polymerisation, phase structure and morphology, elastic and viscoelasticity, creep, dielectric and insulation behaviour and so on.)

It is important we understand that using materials performance index to select our material of choice and the associated selection tools we use such as the Cambridge Engineering Selector are only part of the story. The final selection must be considered in holistically e.g. in how it may be processed and the effect on its properties, its working environment and lifespan and any other mechanical or functional properties it may require. To illustrate this in section 2.1 and 2.2 we will examine one case study in which a simple performance index is generated and combined with cost indicate the suitability of simple polymers. It is important that we understand the selected materials structure and how that influences its properties and processing, section 2.3. Importantly we need to investigate how the potential selections stands up to other considerations such as processing, section 2.4, gas permeability section 2.5, creep, section 2.6, loading and environment sections 2.7 and 2.8. Sections 3 explores a common design criteria of a deflection limited design while sections 4 and 5 cover utilizing polymers useful properties of elasticity in seals and hinges. Some of the common polymers used for these applications will be explored along with their structure property processing relationships.

2. Detailed Case Study: Pipes for Low Pressure Gas Distribution

Background

The distribution of natural gas in the UK is a very important to provide energy sources. A national grid collects and distributes gas from the North Sea, and the total network, with connections to 14 million domestic and industrial consumers, has a length exceeding 200000 km.

In the UK, there are nine main entry terminals, three of accept LNG tankers and three more by four international pipelines (Norway, Netherlands, Belgium and Ireland). They categorized into the following:

National High-Pressure Transmission: The National Transmission System (NTS) operated by National Grid plc. The NTS has 7,600 km of large diameter steel pipelines (63 to 1200 mm) and >20 compressor stations along its length which maintain the pressure in the network.

The NTS transports gas from terminals to 120 offtakes installations at 85 bar that supply 8 regional domestic transmission systems, and > 40 large industrial consumers such as power stations at 25 bar. The NTS also has 8 large-scale storage sites, with 9 more planned.

Regional Distribution: 275,000 km of small diameter pipes. Gas pressure is reduced in stages before reaching residential consumers. Individual distribution networks have their own gas storage facilities for coping with demand variation and also utilise the volume of gas flowing in the pipeline network itself as buffer storage, called linepack.

We will consider gas distribution at the regional distribution level, where polymers have replaced cast iron.

2.1 Previous materials Material Choices

It is always worth considering what has been used previously in a materials selection process.

Cast iron was the material of choice for low pressure distribution mains all over the world until the 1950s. Pipelines typically consist of 12-foot sections connected by bell and spigot joints, shown in that are sealed by jute packing plus cement or molten lead. Leaks tend to develop in the packing over time due to heavy overhead traffic, freeze-thaw cycles, naturally shifting soil, and the switch to dryer natural gas.

Cast iron introduced over 150 years ago for gas and water pipes. However, there are several key problems indicated during its application, such as corrosion, brittleness, leakage and expertise/time restraints to join. Replacement of cast iron pipes by polymers started in 1970s and are still being replaced. So let us look at why this may be, how we can generate a suitable Performance index and other considerations that need to be investigated.

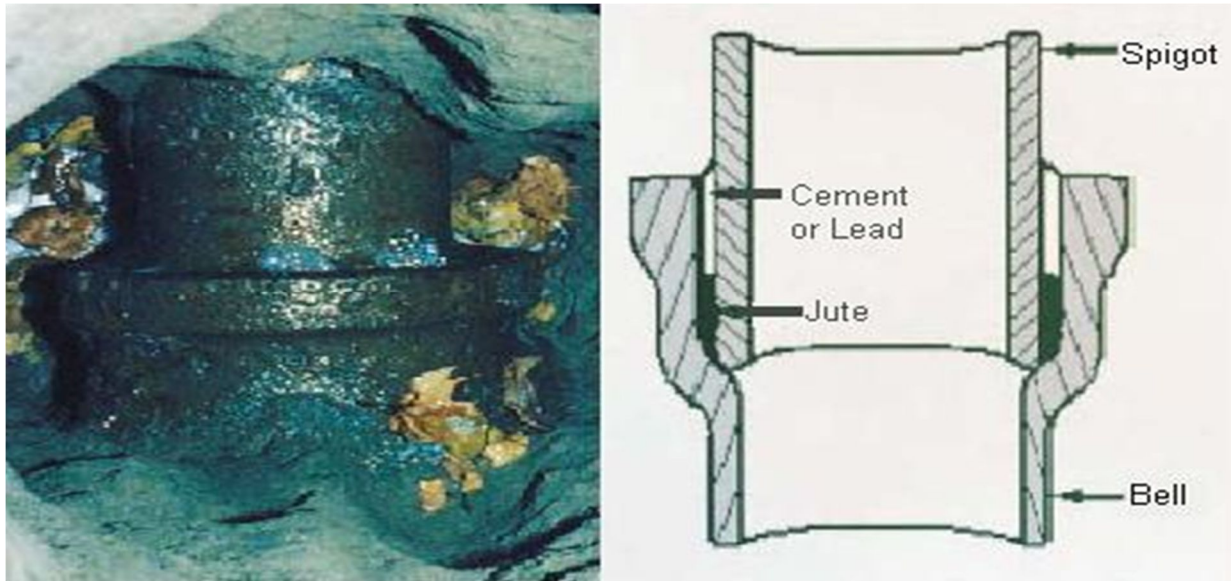

Figure 1: Typical elements in cast iron pipes

There are many materials properties to consider. When choosing materials for low pressure distribution pipes, material which have properties that can maintain their strength when loaded over time are mostly desirable since pipes mostly buried in the soil for a long time. Toughness is another critical material property. The explosive nature of gas/air mixtures was known from the Putney gas explosion in the UK in 1970s, whereas a leakage of pipes caused injuries of many people in residential area. Therefore, strength, toughness and cost will be critical criteria for selecting the best materials for this application.

The properties also vary with processing and in service depending on environmental conditions. This is where we use materials knowledge, understanding of the principles and engineering experience to explore the most likely selection criteria using self-generated data tables or materials section tools like the Cambridge Engineering Selector (CES). We will adopt both approaches depending on complexity throughout this course, starting with the selection of a polymer for low pressure gas pipes.

2.2 Materials selection based on Condition of Fracture

Function: Gas pipe

Objective: delivering low pressure natural gas (<2 bar), safely under and over ground with low gas leakage for 50 years at a low installation and low manufacturing cost.

Constraints: must yield before break and of low cost. Must also be environmentally and mechanically stable, sufficient toughness and strength, relatively impermeable to gas diffusion.

Free variable: choice of material.

For choosing polymer for low pressure gas distribution, we want the pipe to “*yield before break*”. In first year (module MM1IMF) you were introduced to fracture toughness:

$$K_{Ic} = Y\sigma(\pi a)^{1/2}$$

Here, the parameter K_I is called the stress intensity factor and provides a measure of how severely the material is loaded near the tip. The subscript I refers to the type of loading. When

the stress intensity factor at the top if a crack reaches a critical value, K_{Ic} , the cracked structure will fail. K_{Ic} is called the plain strain fracture toughness of a material often shortened to fracture toughness.

Y is dimensionless and depends on shape of the structure, while a is related to the length of the crack, for example a through crack has length $2a$ while an edge crack has length a .

Thus to prevent plain strain fracture, i.e a crack exceeding a critical length a_c in a polymer pipe of yield stress σ_y then :

$$a_c \leq \frac{1}{\pi} \left(\frac{K_{Ic}}{\sigma_y} \right)^2$$

We can use this as a Performance Index to rank the polymers. Table 1 shows the ductility factors for several type of polymers.

Polymer	$K_{Ic} / \text{MN.m}^{-3/2}$	$\sigma_y / \text{MN.m}^{-2}$	Ductility factor
Polyethylene (PE)	5.0 at -60°C	15.8	31.8 mm
Polypropylene	3.5 at -70°C	26.4	5.59 mm
Polyvinyl Chloride	4 at -20°C	57.0	1.57 mm
Polymethylmethacrylate	1.4 at 23°C	80	0.10 mm
Polycarbonate	3 at -20°C	79	0.46 mm

Ductility factor is an example of a performance index, (sometimes called a merit index) so denoted M . Note we could easily simplify the materials performance index to:

$$M = \frac{K_{Ic}}{\sigma_y}$$

Which would rank the materials in a similar order. This is a yield before break materials performance index used for pressure vessels and we can explore a fracture toughness versus yield strength selection chart, such that provided by CES. By logging both sides of the equation it can be easily shown that plotting log toughness versus log of yield strength the performance index has a slope of 1. **See Polymer Question 1 (PQ1) handout.** This can be used to make a materials selection. However as can be seen there are many options. However if we include price per kg , P in the materials selection then the selection chart is as shown in figure 4

$$M = \frac{K_{Ic}}{\sigma_y P}$$

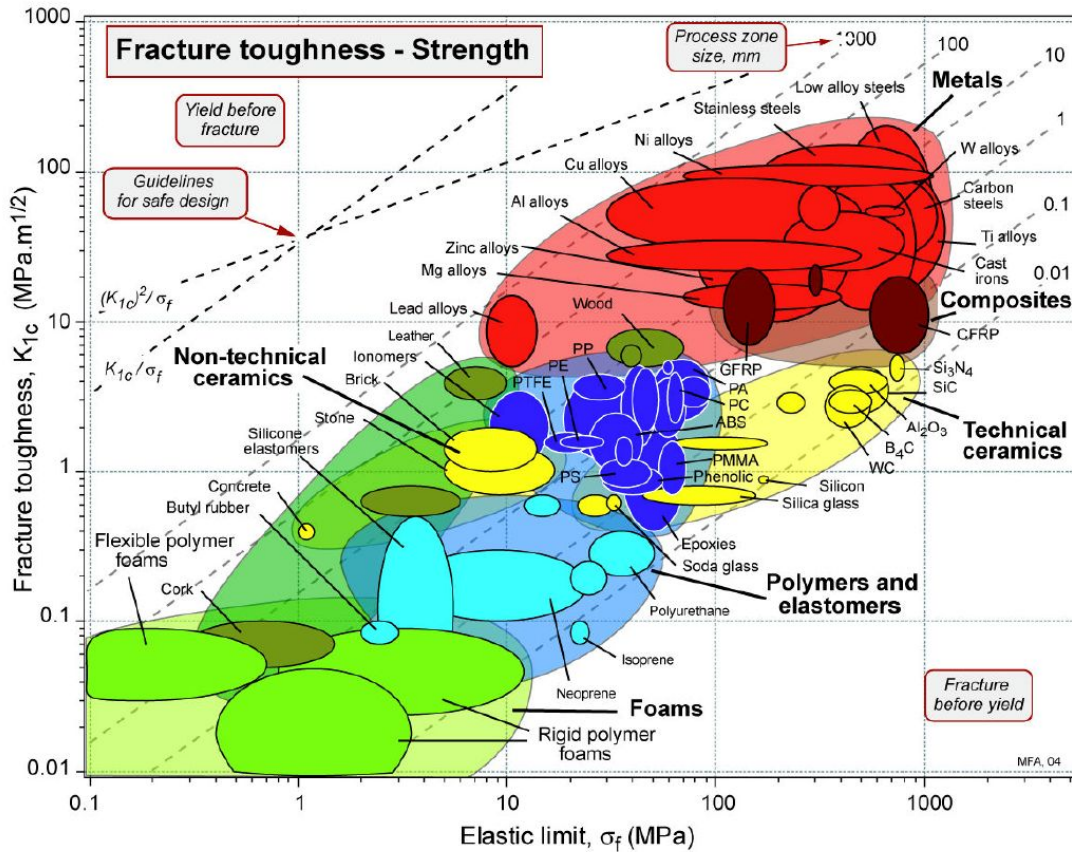

Figure 2: Material selection chart of Fracture toughness vs strength

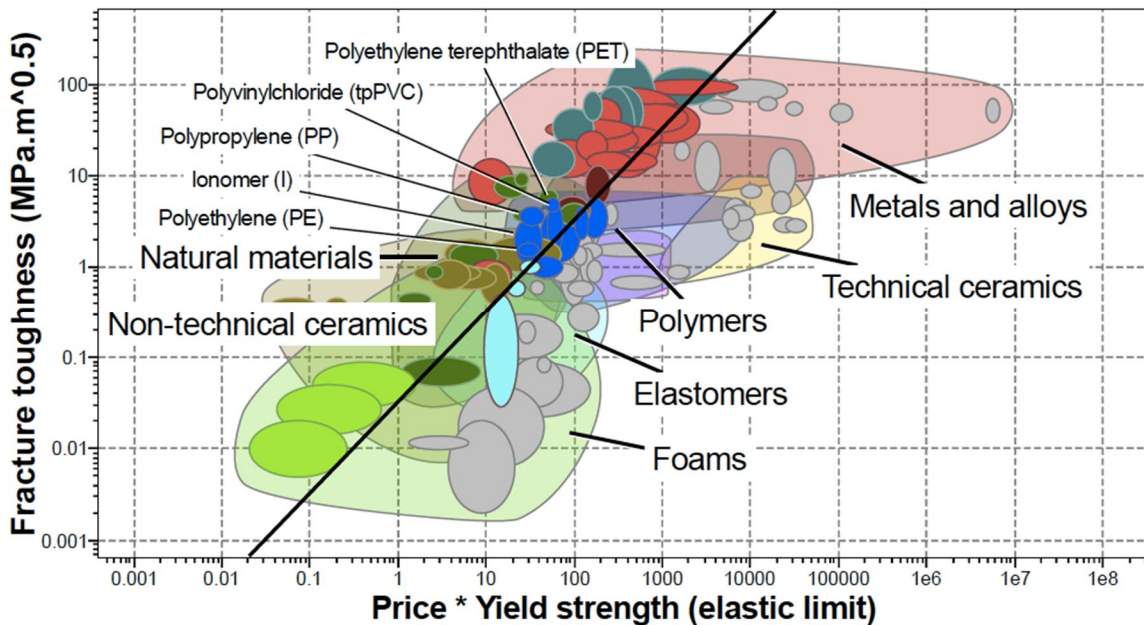

Figure 3: Material selection chart for Fracture toughness vs (price x strength)

The foams and natural materials to deliver the fracture toughness and strength would be too bulky and are too porous for a low pressure gas pipe. The ceramics are below the line having too low a toughness. Thus as you can see metals and polymers tend to be used for pressure pipes. The metals need high cost fittings to join. The metals need expensive fittings

or costly joining techniques at each section for the low cost low pressure pipe network. The price used in figure 4 is the materials price and does not include processing cost. Also as you will see in the lectures welding continuous polymer pipes is relatively straight forward and requires only modest temperatures. So simple polymers of which the most commonly used is PE offer a suitable choice for a large low pressure gas distribution network. The following section looks at the importance of the materials structure even for a simple polymer.

2.3 Influence of the materials structure

In Materials in Design we must consider the materials structure. This is important to understand its properties and how it may be processed and how processing may affect its final product properties. Let us do this for PE.

Polyethylene (PE)

Polyethylene (PE) is the simplest form of polymers which consist of hydrogen and carbon atom. It is manufactured by adding of ethylene in the polymerization.

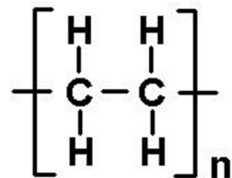

Polyethylene polymer

The basic structure of PE determine its properties. The polymer is compact and tightly packed together so making it insensitive to solvents which resulted in low polarity. That is why PE is very good as an electrical insulator.

At temperatures above T_g the C-C-C bonds rotate freely with a bond angle of 112° and H-C-H at 107° (close to the tetragonal 109.5°) thus chains can form random coils of amorphous regions.

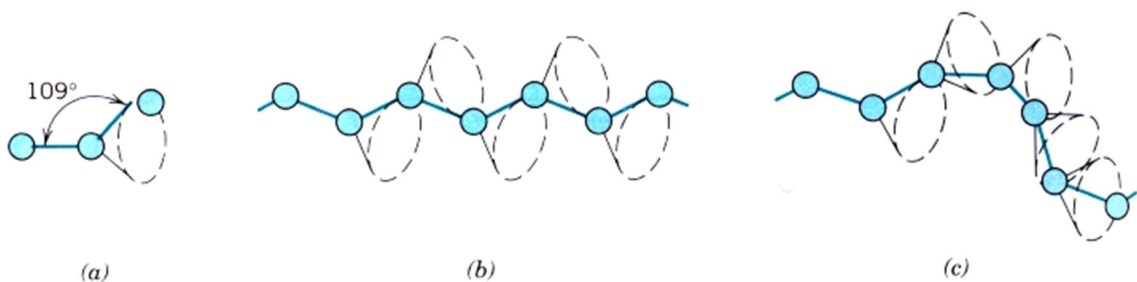

PE molecules can also assume a rod like shape (since PE is planar zig-zag) and a more crystalline structure.

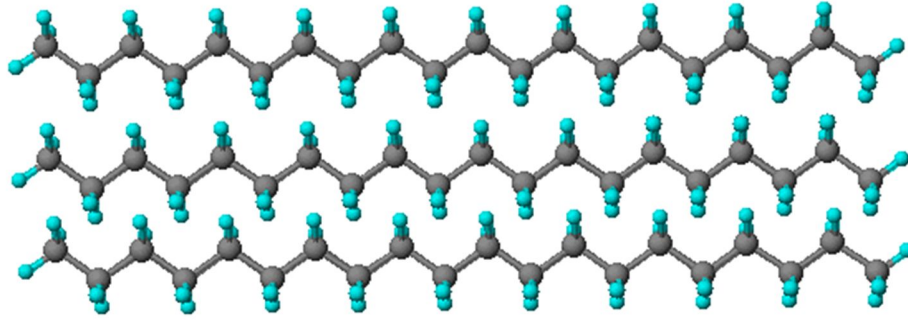

PE contains large numbers of heterogeneous nuclei e.g. from catalyst residues or trapped high M_w molecules in foreign particles. On cooling from the melt – lamellae crystals grow from the edges of the crystal plates. Thus it expands laterally to several microns while thickness of the lamella plate remains at 10 -15 nm. Lamella from next to it at slight angle mismatch and wheat sheaf structure forms until a spherulite is completed. In PE the b axis of the crystal structure while the a and c axes of spiral outwards giving banded appearance. Between lamellae are most of the chain branches and intercrystalline links, these links prevent lamellae from sliding over each other.

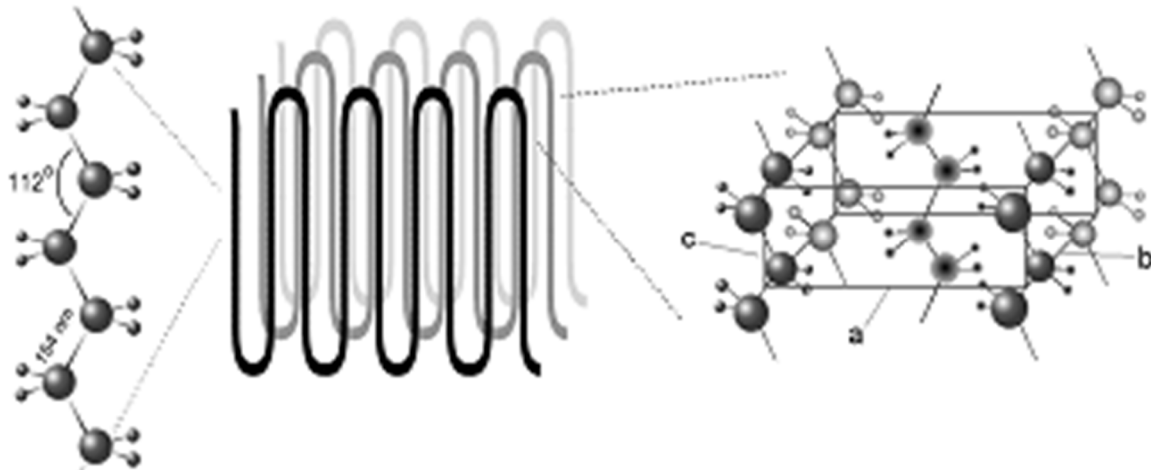

Semicrystalline polymers: Polymer crystals are always separated from each other by amorphous layers. Thus a crystalline polymer is really partly crystalline and partly amorphous, thus more correct to call it semicrystalline.

Non-crystallising polymers (amorphous) :glassy polymers, such as polystyrene, PMMA and polycarbonate, polymers known for their transparency. Elastomers, or rubbers, such as polyisoprene, or butyl rubber, often filled with particles to increase their stiffness and resistance to wear, making them opaque.

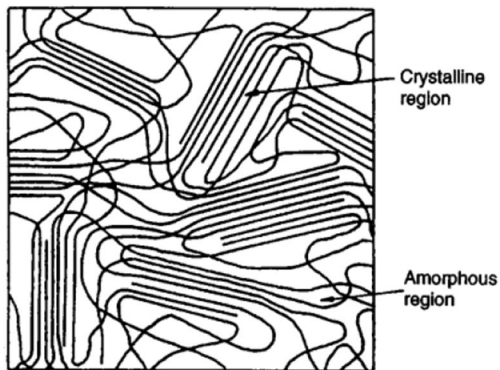

The fringed micelle model

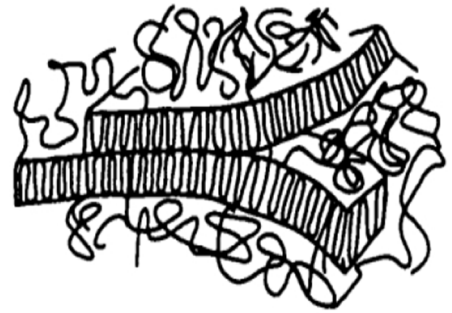
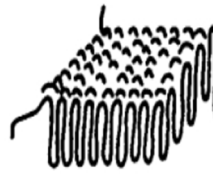

The folded chain model

There are few types of PE :

Low Density Polyethylene (LDPE) - Low density Polyethylene (LDPE), $915 - 925 \text{ kg m}^{-3}$, is processed under high pressure 1-2 kbar and high temperatures $100 - 300^\circ\text{C}$. Characterised by very branched molecules reducing the efficient and rapid arrangement of molecules during crystallisation. Thus low crystallinity (40-65%), $T_m \sim 110^\circ\text{C}$, $T_g \sim -120^\circ\text{C}$.

Applications: Films, bags, transparent parts, packaging, bubble wrap, flexible caps.

High Density Polyethylene (HDPE) - High density polyethylene (HDPE), $945 - 960 \text{ kg m}^{-3}$: Processed with an active catalyst at lower pressure 30 bar and lower temperatures $40 - 150^\circ\text{C}$. characterised by long linear molecules very branched molecules. Therefore high crystallinity (85-95%), $T_m \sim 130^\circ\text{C}$, $T_g \sim -120^\circ\text{C}$. Applications: Pipes, pails, covers, chemical containers, jars, tanks.

Linear low density polyethylene(LLDPE) -LLDPE: Linear low density polyethylene(LLDPE), $910 - 925 \text{ kg m}^{-3}$. Processed at lower temperatures than LDPE and is a mostly linear polymer with significant numbers of short branches, commonly made by copolymerization of ethylene with short-chain alpha-olefins (for example, 1-butene, 1-hexene and 1-octene).

Advantages: Higher tensile strength, impact and puncture resistance than LDPE and lower thickness (gauge) films can be blown with environmental stress cracking resistance.

Applications: packaging, particularly film for bags and sheets due to its toughness, flexibility and relative transparency , Other applications include cable covering, toys, lids, buckets, containers and pipe.

Medium density polyethylene (MDPE) - Medium density polyethylene (MDPE), $0.926 - 0.940 \text{ g/cm}^3$. Processed by mechanically mixing LDPE and HDPE thus intermediate properties between the two. Alternatively can be catalysed directly using a range of catalysts (e.g. chromium/silica). Applications: engineering applications such as water and gas pipes due to its shock and drop resistance also it is less notch-sensitive and its stress cracking resistance is better than HDPE. Other applications include sacks, shrink film, packaging film, carrier bags.

Ultra High Molecular Weight Polyethylene (UHMWPE) - Ultra high molecular weight polyethylene, $930 - 940 \text{ kg m}^{-3}$. Typical High molar mass, M_w , 3 – 6 Million giving it high toughness but difficult to form crystal structure. Crystallinity only 45%. However, the high

Mw means these long molecules produce more intercrystalline link in the microstructure and increases the yield stress through orientation hardening. UHMPE also has improved abrasion and chemical resistance, resistance to impact and cyclical failure, higher hardness and a low coefficient of friction. But the high Mw means its Melt Flow Index is very low and cannot be processed by conventional injection moulding, blow moulding or extrusion. Instead it has to be processed by compression or machined. Applications: Ideal for bearing surface in biomedical implants, also used in marine barriers, rods, pumps and bearings, gaskets and high toughness applications as in protective armour vests.

2.4 Processing of Polymers

Having selected a material or materials as with PE in this case study and understood its structure we need to understand how the materials properties not only meet the design but also what options are available for how the material may be processed.

There are many manufacturing processes that are commonly used, such as extrusion, injection molding, and rapid prototyping. The material properties influence how readily the material can be formed into its final shape and processing conditions influence the final polymer properties!

For example, high temperatures can lead to polymer breakdown and loss of molecular weight or exposure to moisture at elevated temperatures can accelerate degradation. As PE is a thermoplastic then most of the processes melt the materials and form it into the desired shapes. To illustrate this property-process interrelationship let us look at a common polymer processing method such as extrusion.

Extrusion

Extrusion is a continuous process that will deliver a continuous stream of a polymer melt that can be subsequently formed into a desired shape.

Most thermoplastics and thermosets can be practically extruded. A low melting index (high molecular weight) is desirable for best extrusion to allow material to hold shape as it leaves the die.

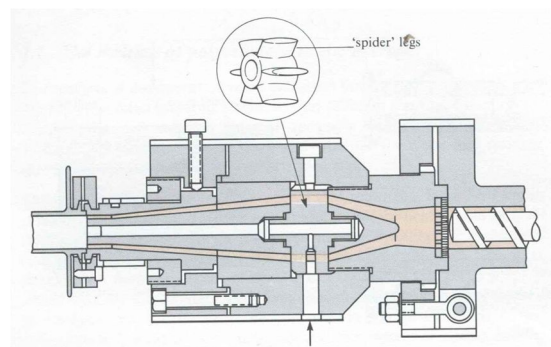
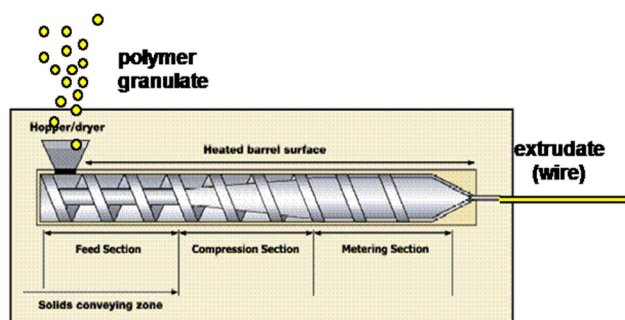

Figure 4: Simple schematic of polymer extrusion process with typical die for producing tube

The extruder screw has three main section:

The solid granules fall under gravity into the **feed section**. The main function of the feed section is to melt polymer granules. This occurs by conduction from electrically heated barrel. The barrel wall usually has longitudinal grooves in the feed section to aid the forward conveying of heated granules to the **compression section**. The channel depth decreases in this section to allow melts (not granules) to pass to the final metering section. **The metering section** of the screw control the extruder output.

The Melting Process

The polymer granules are fed from the hopper into an extruder screw (sometimes a twin screw arrangement, specifically for a very heat sensitive materials such as PVC or CPVC). As the granules are conveyed forward by the screw the melt pool and film extend until at the end of the screw all is melted. This distance or residence time is critical as you require the polymer to minimize its time at temperature to avoid degradation. Clearly an important property for processing is viscosity. While polymers viscosity can be measured in the lab using a viscometer, in industry an empirical method is used to determine the melt flow index.

Melt Flow Index (MFI)

An empirical method to determine how a given polymers will flow when melted (melt viscosity) of polymers. MFI is used for quality control of polymer molecular weight.

Using the exact dimensions in Figure 5, the MFI is the output in grams when a 2.16 kg mass is used to extrude the polyethylene. Range is typically 0.01 for high viscosity high molecular weight polymers and 50 for easy flowing injection mould grades. As MFI increases, the polymers melt flow more easily.

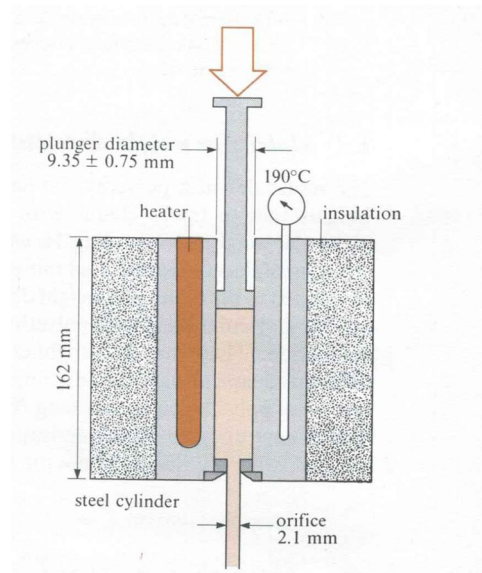

Figure 5: Melt Flow Indexer

Melt Flow Index problems: Many factors affect polymers' flow properties. Molecular weight distribution, the presence of co-monomers, the degree of chain branching and crystallinity as well as heat transfer. Also the shape of a melt flow curve of shear stress versus shear strain rate depends on molecular weight distribution.

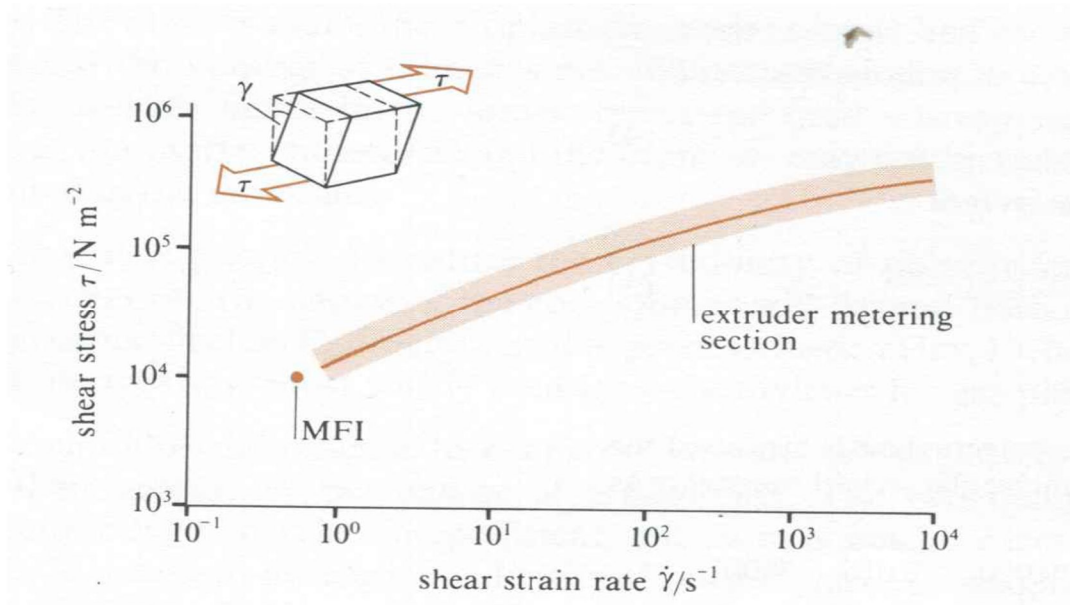

Figure 6: Shear stress vs. shear strain rate at different MFI

Extruder Processing – Property considerations

Viscous Heating

The viscosity of the polymer often leads to considerable viscous heating which strongly influences the process, **see Polymer Question 2 (PQ2) handout**

Screw speed – Screw rotation is to provide viscous heating of the melt polymers. If screw speed too fast, then insufficient residence time to melt the polymer. For PE the melt emerging from the die should be 200 -220°C and give a smooth surface. The melting process can be unstable, with breaks occurring in the solid bed continuity. These cause pressure fluctuations at the die, and hence fluctuations in the volume output rate, which cause the pipe wall thickness to vary. Such fluctuations are more likely when the screw speed is increased; the polymer residence time in the extruder can become insufficient for complete melting. Some screw designs place a barrier in the compression section that allows melt, but not granules, to pass; the final metering section smoothes out any pressure variations.

Excessive temperatures through viscous heating will degrade the polymer and allow oxidation to occur, especially in the inside of the tube which cools slower.

Extruder output - The extruders are designed to allow “drag flow” to dominate, that is flow due to the screw motion. There is a pressure drop which is proportional to h^3/η where h is the channel depth, which gives “pressure flow”. The design of the extruder should make pressure flow to be less than 10%.

2.5 Exploring other constraints of the case study:- Gas permeation

Exploring materials selection using Function, Constraints, Objective and Free variable is one method in delivering the right product. We need to explore how the pipes function of a “gas pipe” meets its objective in “delivering low pressure natural gas, safely with low gas leakage for 50 years at a low cost”.

For example we need to explore the processing of the pipe, in terms of mass production and ensuring there are sufficient properties of the pipe in service in relation to the physical and chemical internal and external environment. We also need to consider how properties may

change from time zero during the processing of the pipe and long term service issues such as creep and environmental attack.

These additional constraints need to be explored and the materials selection validated. This is illustrated in as follows:

Pipe Internal Environment

Natural gas is mostly methane plus other hydrocarbon gases plus conditioning agents that are added to protect parts of the network that still may be cast iron.

Natural (North Sea) Gas		Volume%
Methane	CH ₄	92.3
Ethane	CH ₃ -CH ₃	3.5
Nitrogen	N ₂	3.1
Propane	CH ₃ -CH ₂ -CH ₃	0.9
Butane	CH ₃ -CH ₂ -CH ₂ -CH ₃	0.2
Carbon Dioxide	CO ₂	Trace

Gas Leakage

CAST IRON - U.S. cast iron distribution mains are estimated to have leaked 250 billion litres of natural gas in 2007. This equates to \$150 million worth of gas or of the fugitive methane emissions from distribution mains account for 32% of methane emissions from the U.S. natural gas distribution sector. Cast iron pipelines contribute the most to these emissions, despite representing only 3% of of the U.S. distribution mains. Typically leakage is 7500 l km-1 yr-1. Leaks tend to develop in the packing over time due to heavy overhead traffic, freeze-thaw cycles, naturally shifting soil, and the switch to dryer natural gas.

PE PIPES - Methane diffuses through PE pipes but by how much? and is it better that the reported leaks in cast iron pipes.

Calculate typical PE pipe losses due to diffusion and compare with the leakage with cast iron leaks. **See Polymer Question 3 (PSQ3) handout**

It is not just the internal environment of the PE gas pipes but the external environment such as exposure to UV radiation before burying and oxygen degradation are important considerations that influence the material properties of strength, stiffness, creep resistance and toughness which are also influenced by the processing of the pipe during manufacture and fusing joints.

2.6 Exploring other constraints: - Creep and Creep rupture

Creep is an increasing strain over time in the presence of constant stress. When polymers are subjected to a static load over time (at constant temperature), it deforms quickly to a strain. Creep in polymers implies time dependent strain not permanent strain. When a creep load is removed then the polymer may slowly recover its shape provided it had not been strained to yield point or a mechanism of failure has started. Therefore, creep in polymers is different from creep in metals where metals experience permanent strain.

If we look again on the gas pipes it is expected that they will experience a static stress. The principal stresses are hoop, longitudinal and radial (reference module) which for a thin walled pressure vessel are:

$$\sigma_{\theta} = \frac{pR}{t}, \sigma_L = \frac{pR}{2t}, \sigma_r = 0$$

Where R is the mean radius and t is the wall thickness
Since

$$\varepsilon_{\theta} = \frac{1}{E} (\sigma_{\theta} - \nu\sigma_r - \nu\sigma_L)$$

$$\varepsilon_{\theta} = \frac{pR}{tE} \left(1 - \frac{\nu}{2}\right)$$

Note we have used a thin wall approximation for the principle stresses which holds provided $R/t > 20$. In this module for simplicity we will still use the approximation even though the gas pipes have $R/t \sim 5$.

The gas pipe needs to last 50 years!! So any new fittings need to fit within tolerance despite any creep. This is set at 3% hoop strain in 50 years.

Thus, we need to allow for the viscoelastic behaviour so we define Creep Compliance $J(t)$ as:

$$J(t) = \frac{\varepsilon(t)}{\sigma}$$

So the stain in a uniaxial tension creep experiment is:

$$\varepsilon(t) = \sigma J(t)$$

While the strain for a material that creeps under hoop stress is:

$$\varepsilon_{\theta}(t) = \sigma_{\theta} J(t) \left(1 - \frac{\nu}{2}\right)$$

We can use this combined with the figure 7 to calculate the maximum internal gas pressure in a pipe of $R/t = 5$ with a poisson ratio of 0.4 to reach 3% hoop strain in 50 years. **See Polymer Question 4 (PQ4) handout**

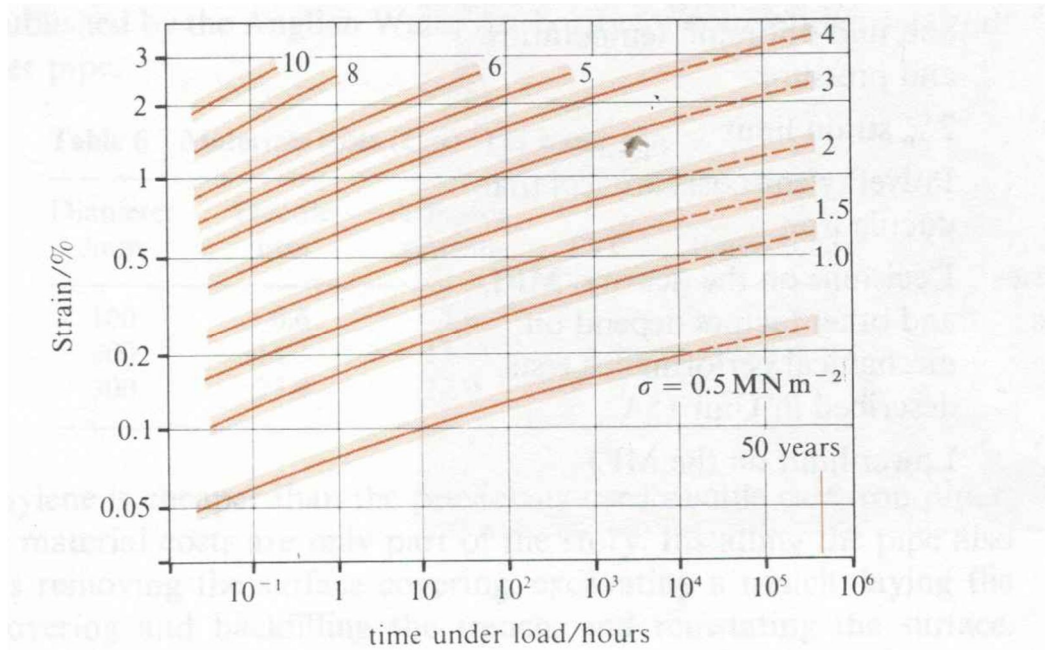
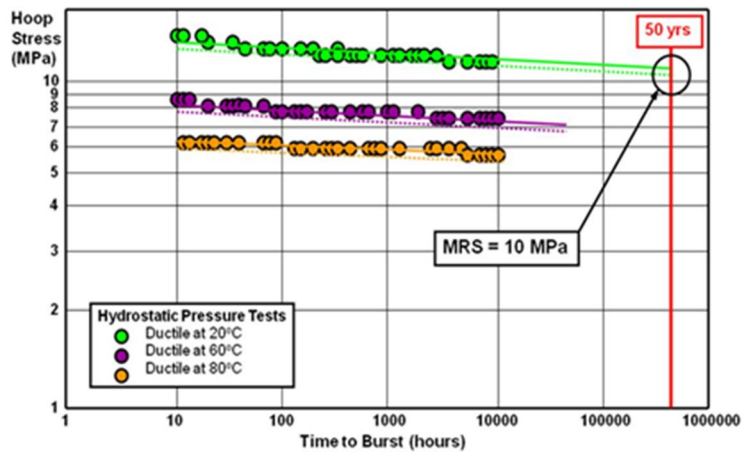

Figure 7: MDPE creep strain /time curves for MDPE test samples under tensile load

Creep Rupture

PE 80 and 100 are ISO standards for a HDPE pipe and indicate minimum strength of 8 and 10 MPa after 50 years.

Hydrostatic pressure tests: Internal pressures are set to give hoop stresses that cause failures from 10 to 9000 hours. A minimum of 30 data points (ISO 9080). PE pipe materials are tested at 20, 60 and 80°C .



2.7 Exploring other constraints: - Soil Loading on buried pipe

Buried flexible pipes have underestimated load-carrying capacity due to the pressure induced at the sides of the pipe as they deform horizontally outward under vertical loading. The interaction between the pipe and the soil packing leads to the empirical Iowa Formula* below:

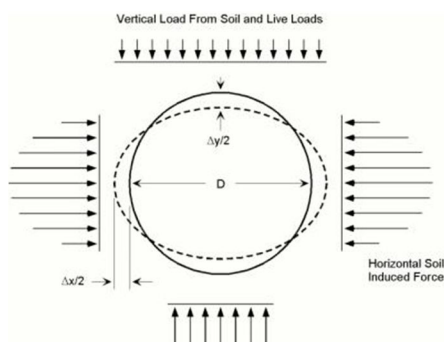

$$\frac{\Delta x}{D} = \frac{D_1 K_z P_v}{\left(\frac{E I_{eq}}{R^3} + 0.061 E' \right)} \quad (\text{Eq. 1})$$

where Δx is the horizontal deflection of the pipe, D is the pipe diameter, R is the pipe radius, $(E I_{eq})$ is the equivalent pipe stiffness. D_1 and K_z are the deflection lag factor and the deflection parameter (sometimes called the bedding constant), which are dependent on the fill conditions, and P_v is the vertical pressure load on the pipe. Accurate calculation of the load on the pipe is a task that will not be discussed here. E' is called the modulus of soil reaction, and is related to the support of the soil. For small deflections, the pipe cross section will remain approximately elliptical, and the vertical deflection Δy is roughly equal to the horizontal deflection Δx . The formula does not include a pressure term, as it was developed to analyze unpressurized pipes.

Calculations using this equation (you do not need to know this equation) based on MDPE with $R/t = 5$ and typical soil loads and predict less than 0.5% diameter change after 50 years.

2.8 Exploring other constraints: - Environmental Stress Cracking

Environmental stress cracking is similar, but not identical to, stress corrosion cracking of metals.

Environmental stress cracking (ESC) - failure at RT due to continuously acting external and/or internal stresses in the presence of surface active substances (stress cracking agents) such as alcohols, soaps, dyes, agents containing moisture. ESC is from the interaction of the polymer with certain chemicals but is **not** a chemical reaction between the polymer and the active environment.

The stress cracking agents do not cause any chemical degradation of the polymer but they accelerate the process of macroscopic brittle-crack formation.

Note if we consider deformation of PE then you can have brittle and ductile failure:

Ductile Failure Under tensile load the tie molecules stretch until the tie molecules can be pulled out no further. The lamellae break up into small units "mosaic blocks" that are directly incorporated into a new fiber morphology. The tie molecules hold the lamellae blocks together, critical for ductile-type behaviour.

Brittle failure is by applying low stress over long periods of time. i.e The stress necessary to achieve large-scale fibre pullout is not attained because the material is under a low stress level.

All liquids that are absorbed by a polymer in a short period may be a severe stress cracking agents. Such liquid/polymer pairs can be easily assessed eg. Environmental Stress-Cracking Resistance (ESCR) - ASTM D1693 which is the number of hours that 50% of the specimens tested exhibit stress cracks. Test samples are notched. Test specimens are bent and placed in a holding clamp. The clamp and specimens are then immersed in a specified reagent in a constant-temperature bath. Multiple test specimens are tested at one time. Specimens are inspected periodically for failure. Cracks generally develop at the notch, perpendicular to the notch, and run to the edge of the specimen. Any cracks constitute failure, not just cracks that reach the edge of the specimen.

Cracks sometimes appear beneath the surface and are visible as surface depressions. If a depression develops into a surface crack the time at which the depression was noted is taken as the time of failure.

ESCR Test Conditions

Condition		Thickness (mm)	Notch Depth (mm)	Bath Temperature (°C)
A	min	3	0.5	50
	max	3.3	0.65	
B	min	1.84	0.3	50
	max	1.97	0.4	
C	min	1.84	0.3	100
	max	1.97	0.4	

Condition A is PE densities 0.910 - 0.925 g/cm³.

Condition B densities greater than 0.925 g/cm³.

Condition C accelerated testing high ESCR materials.

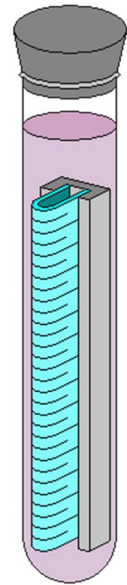

Stress Cracking Agents

Liquids with weak hydrogen bonding are usually stress cracking agents - organic liquids as aromatic hydrocarbons, halogenated hydrocarbons, ethers, ketones, aldehydes, esters, and nitrogen and sulphur containing compounds.

Aliphatic hydrocarbons and liquids with strong hydrogen bonds, for example water and alcohols, are less aggressive agents. Liquids close to their boiling point and low viscosity are more aggressive agents.

Typical solvents that cause stress cracking in most amorphous polymers include petroleum ether, carbon tetrachloride, toluene, acetone, ethanol and chloroform.

Plastic medical device components can often suffer ESC due to the exposure to compounds as **isopropanol and lipid solutions**.

Duration of ESC

The transition to brittle behaviour is accelerated to shorter times by increasing temperature, cyclic loading, dilational stress, stress concentrations. Localized concentration of the stress due to local geometrical features as notches, voids, and inclusions will increase the stress and modify the nature of the stress field.

Craze initiation is accelerated by stress fields with high dilational stress and retarded under hydrostatic pressure

3. Case Study: Acetabular cup- hip replacement

Introduction

Metal-on-metal total hip replacements showed a much higher failure rate than other options which was linked with their high wear rates. Researchers (Smith et al., Lancet 2012; 379: 1199–204) analysed the National Joint Registry of England and Wales for primary hip replacements (402 051 cases, of which 31 171 were stemmed metal-on-metal) undertaken between 2003 and 2011 and found that approximately 6.1% of metal-on-metal hips had failed within five years, while only 1.6% of metal-on-polymer had failed within the same period.

Function: Acetabular cup for hip replacement

Objective: delivering low wear rate

Constraints: must be physically and mechanically stable under physiological conditions, able to sterilised, does not leach-out harmful materials....

Free variable: choice of material

When surfaces slide, both surfaces lose materials (wear). The wear-rate, W , is defined as

$$W = \frac{\text{Volume of material removed from contact surface}}{\text{Distance slid}} \quad (\text{m}^2)$$

Specific wear-rate (wear-rate per unit area)

$$\Omega = \frac{W}{A} \quad (\text{Dimensionless})$$

Specific wear-rate is directly proportional with bearing pressure (P),

$$\Omega = K_a P$$

where K_a is wear constant

The maximum bearing pressure P_{max} should scale with the hardness H of the softer surface

$$P_{max} = C H$$

Where C is a constant

$$\text{Therefore, } \Omega = K_a P = \frac{K_a P P_{max}}{P_{max}} = C \left(\frac{P}{P_{max}} \right) K_a H$$

$$\text{Performance index, to minimise wear rate } M = \frac{1}{K_a P}$$

Take log for both sides of the equation

$$\log M = \log 1 - \log K_a - \log H$$

Rearrange the equation

$$\log K_a = -\log H - \log M$$

Therefore, the relation between wear constant and hardness will be a line with -1 gradient.

From wear rate versus hardness, wear rate for metals is 4 orders of magnitude higher than PE. Therefore, UHMWPE was selected for this application. Structure and properties of UHMWPE were discussed earlier in this notes.

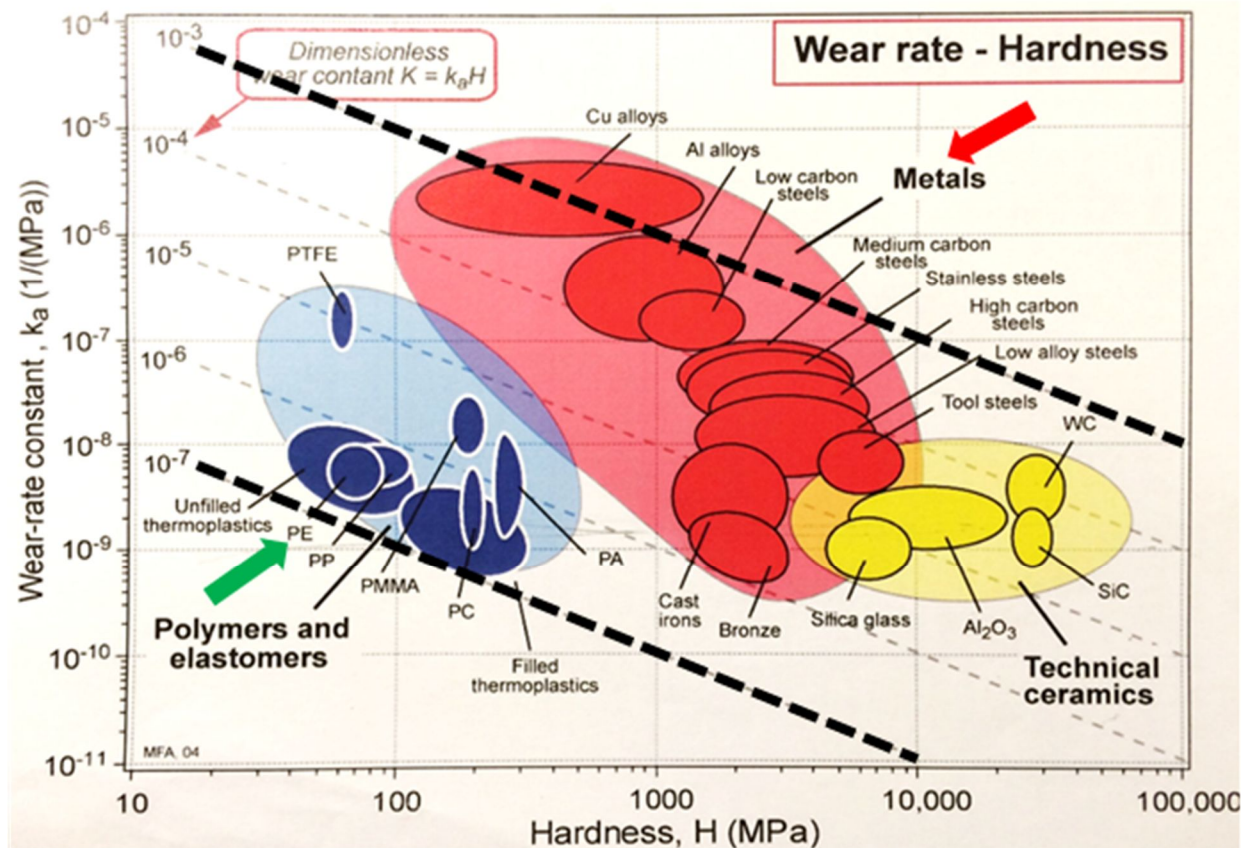

Figure 8: Material selection chart of wear-rate constant versus elastic hardness.

4. Case Study: Deflected Limited Design (Snap clips/Lids)

Design requirements for snap clips/lids :

Function: resist brittle failure

Objectives: secure fitting or lid at low cost

Constraints: Deflection specified by design

Free variable: Choice of material

Snap-on bottle tops, snap together fasteners, and such like are displacement limited product must allow sufficient elastic displacement to permit the snap action without failure, requiring a large failure strain ϵ_f .

When a brittle material is deformed, it deflects elastically until it fractures. The design must allow sufficient elastic displacement to permit the snap action without failure, requiring a large failure strain . When a brittle material is deformed, it deflects elastically until it fractures. The stress that will happen is :

$$\sigma_f = \frac{CK_c}{\sqrt{\pi a_c}}$$

where :

K_c = fracture toughness,

a_c = length of the largest crack contained in the material

C = a constant that depends on geometry

The strain that relate to stress is $\epsilon = \sigma/E$

Therefore the failure strain is :

$$\epsilon_f = \frac{C}{\sqrt{\pi a_c}} \frac{K_{1C}}{E}$$

The best materials for displacement limited design are selected with maximum value of performance index :

$$M = \frac{K_{1C}}{E}$$

Plot fracture toughness (K_{1C}) and young modulus (E) and lines with slope = 1 have the same performance index. .see figure 8

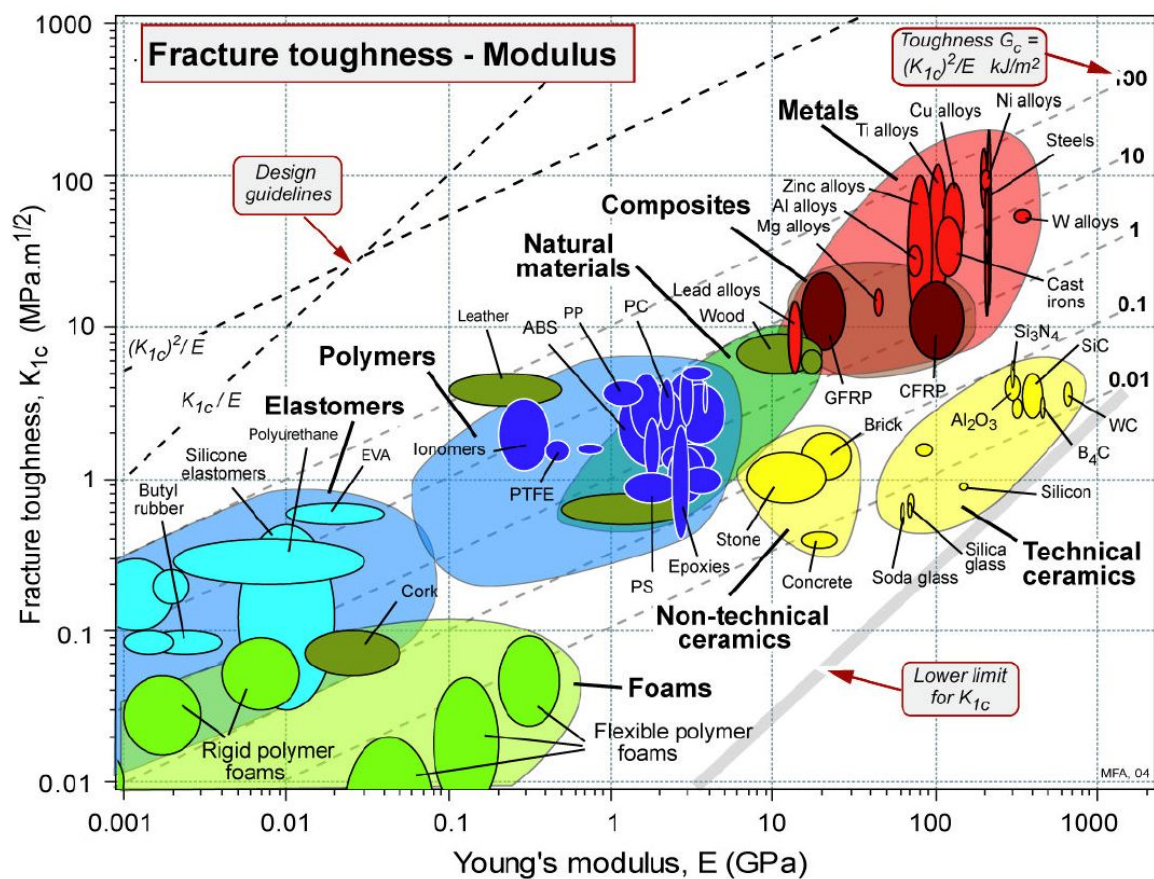

Figure 9: Material selection chart of toughness versus elastic modulus.

There are many choices of polymers for this application, however the most commonly used is Polypropylene (PP). Let us consider its structure and properties

Polypropylene(PP) is the second most widely used polymer after Polyethylene(PE). PP is more rigid than PE, used in tapes, plastic bottles, caps of bottles, car parts, (also fibre-reinforced), textiles (ropes, carpet fibres). 60% of the total production of PP is as a

homopolymer. PP is one of the light thermoplastics. Typical density 905 kg m^{-3} with $T_m \sim 167^\circ\text{C}$, and $T_g \sim -20^\circ\text{C}$ and a crystallinity of $\sim 50\text{-}60\%$. PP, unlike PE, is transparent.

PP Co-polymers

Random co-polymers - polymerizing together ethene and propene. Ethene units, usually up to 6% by mass, are incorporated randomly in the poly(propene) chains

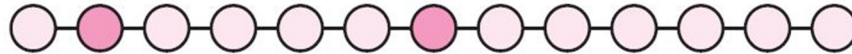

The crystallinity and melting point are reduced and the products are more flexible and are optically much clearer. Random co-polymers are used for medical products (pouches, vials and other containers) and packaging (for example, bottles, CD and video boxes).

Block co-polymers

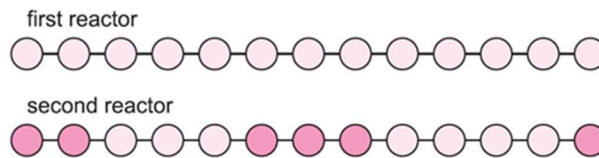

The ethene content of the block co-polymer is larger (between 5 and 15%) than used in randomly alternating co-polymers. It has rubber-like properties and is tougher and less brittle than the random co-polymer is useful in making crates, pipes, furniture and toys, where toughness is required. When ethene, propene and a third monomer, a diene, are polymerized, a rubber is formed, known as EPDM (Ethene, Propene, Diene, polyMethylene).

5. Case Study Elastic Seals

Function: Provide a leak tight elastic seal

Constraints: limit on contact pressure required to prevent damage (typically $< 100 \text{ MPa}$)

Objectives: low cost, maximum conformity to surface

Free variable: Choice of material

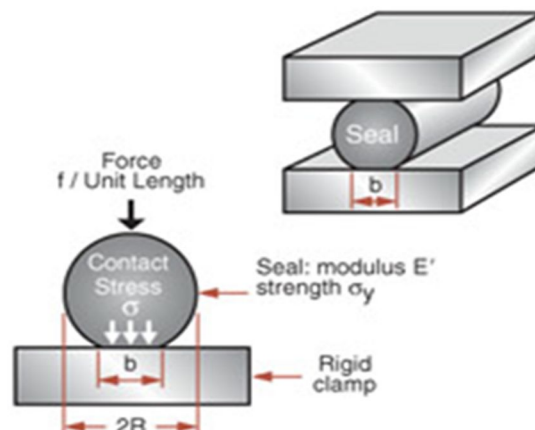

A materials in the shape of a cylinder of radius R and modulus pressed into a flat surface will create a flat contact width, b, which is related the yield (or failure) stress and elastic modulus as follows:

$$b \leq 4.0 R \left(\frac{\sigma_y}{E} \right)$$

Thus contact width is maximised with a Performance Index of:

$$M = \left(\frac{\sigma_y}{E} \right)$$

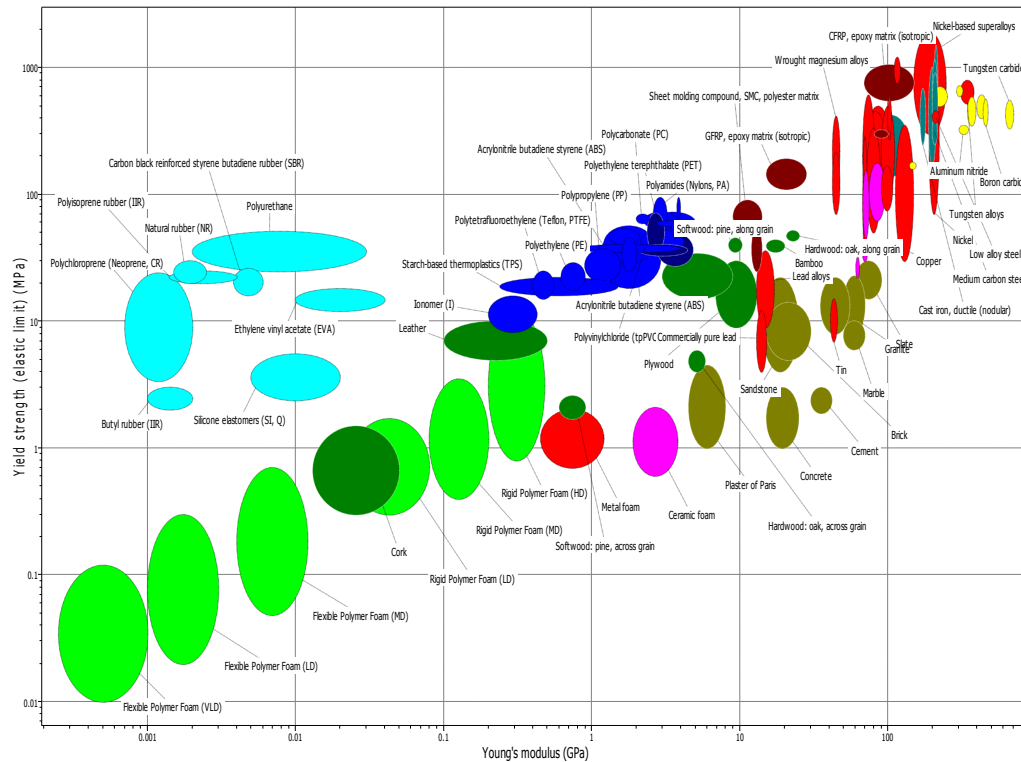

Figure 10: Material selection chart of strength versus elastic modulus.

The analysis highlights the functions that seals must perform: large contact area, limited contact pressure, environmental stability. Elastomers maximize the contact area; foams and cork minimize the contact pressure; PTFE and silicone rubbers best resist heat and organic solvents. The final choice depends on the conditions under which the seal will be used. Elastomers meet the performance index allowing for the constraint “maximum stress to prevent damage to surface is 100 MPa”. Polyurethane (PU) has the highest Merit Index especially when cost is a factor. Thus it is no surprise that PU is widely used for seals. Additional constraints environment (chemical attack, temperature) which may lead to other choices

Structure and properties of PU.

Polyurethanes PU is unlike most other plastics in that there is no urethane monomer and the polymer is usually formed during the manufacture of an object.



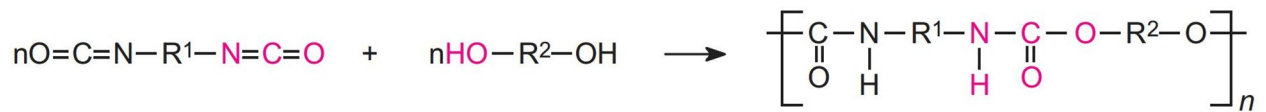

Polyurethanes are thermosets made by exothermic reactions between alcohols with two or more reactive hydroxyl (-OH) groups per molecule (diols, triols, polyols) and isocyanates

that have more than one reactive isocyanate group (-NCO) per molecule (diisocyanates, polyisocyanates). For example a diisocyanate reacts with a diol:

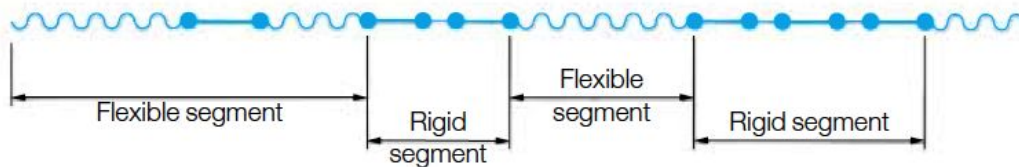

The group formed by the reaction between the two molecules is known as the urethane linkage.



-  = Residue of long-chain diol (ether/ester)
-  = Residue of short-chain diol
-  = Residue of diisocyanate
-  = Urethane group

Flexible segments are created by the reaction of the polyol with the diisocyanate. The combination of diisocyanate with short-chain diol produces the rigid component (rigid segment)

The physical properties, and the chemical structure, of a polyurethane depend on the structure of the original reactants, such as the R1 and the R2 groups. The characteristics of the polyols - relative molecular mass, the number of reactive functional groups per molecule, and the molecular structure - influence the properties of the final polymer, and hence how it is used and makes it one of the most versatile polymers.

Polyurethane, PU

Density 1.12 to 1.24 g cm⁻³

T_m 120 -160°C,

Wide range of T_g -60°C to +60°C

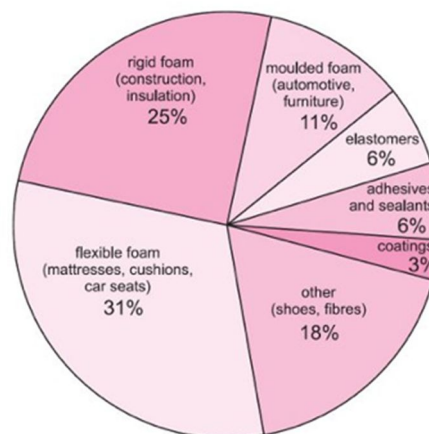

For example it can be used effectively in the sealing of component parts from aerospace to household to medical devices to thermal insulation, moulded foam for furniture, coverings, electrical insulation, sealants, footwear, protective paint and so on.

6. Case study: Elastic Hinges

Function: Recoverable elastic hinge

Objectives: Maximum elasticity without failure

Constraints: Highest radius of curvature

Free variable: Choice of material

The surface strain of hinge of thickness, t , and radius R is:

$$\varepsilon = \frac{t}{2R}$$

Thus maximum stress is:

$$\sigma = E \frac{t}{2R}$$

Minimum radius must be:

$$R \geq \frac{t}{2} \left(\frac{E}{\sigma_f} \right)$$

Max radius of curvature is $1/R$ so

Therefore Merit index is:

$$M = \frac{\sigma_f}{E}$$

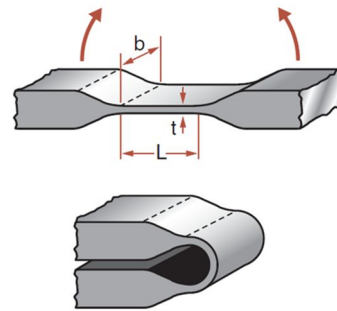

Note this is similar as previous example, see figure 9 materials selection chart.

Elastic Hinges: finger implants

So like with the elastic seal application the elastomers show superior performance if you are not constrained by requiring a higher stiffness. Let us consider additional constraints of cost, stiffness, biocompatibility and durability.

PU is a factor 3-5 times more cheaper but the materials cost is not often constraint on a medical implant (unless it is a high volume one like a catheter).

PU and silicone are both biocompatible and both have low surface energy which makes them hydrophobic.

However PU is used as candidate heart valve material as it has higher stiffness, see chart, and is non thrombogenic, while silicone is used for finger joints due to its durability at high strains

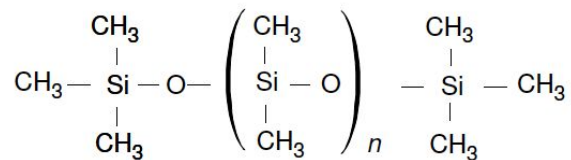

Poly(dimethyl)siloxane (PDMS)

Most common silicones have methyl groups along the backbone. Properties such as solubility in organic solvents, water-repellence and flexibility can be altered by substituting other organic groups for the methyl groups.

Silicones with phenyl groups are more flexible polymers than those with methyl groups. They are also better lubricants and are superior solvents for organic compounds.

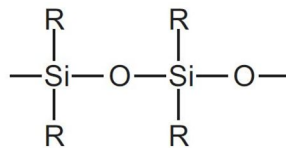

Where R can be:

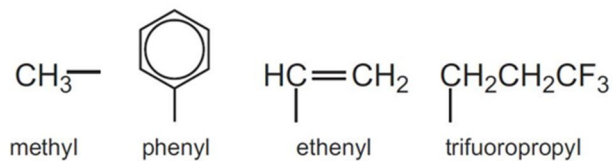

Silicone - Most common silicones have methyl groups along the backbone. Properties such as solubility in organic solvents, water-repellence and flexibility can be altered by substituting other organic groups for the methyl groups. Silicones with phenyl groups are more flexible polymers than those with methyl groups. They are also better lubricants and are superior solvents for organic compounds.

Silicone fluids/ gels/ elastomers/ resins - The silicones with short chains are fluids and have an almost constant viscosity over a wide temperature range, -75 to 175°C. They also have very low vapour pressures. The low surface tension of silicone fluids makes them ideal for

lubricants in polishes, paints, water-proofing fabrics, paper and leather. They also have anti-foaming properties – sewage plants.

Low enthalpy of vaporization and a smooth, silky feel and thus are used for personal care products such as perspirants and skin care lotions. The different properties of fluids is made by mixing polysiloxanes of low molecular masses with higher molecular masses.

Silicone gels have few cross-links between the chains, giving it a very open three-dimensional network. Cross-linking is done after a silicone fluid, together with a reactive group, is poured into a mould and then warmed or catalysed. Used for protecting sensitive electronic equipment from damage from vibration and also acts as an electrical insulator. Pads containing a silicone gel - shock absorbers in shoes.

Silicone elastomers - more cross-linking into the linear chain polymers. Their structure is determined by the amount of cross linking and the length of the chains. Strength at room temperatures is inferior to that of natural rubber, but silicone rubbers are more stable at both low temperatures $-75\text{ }^{\circ}\text{C}$ and high temperatures $> 175\text{ }^{\circ}\text{C}$ and more resistant to chemical attack. Silica is added as a filler to make the elastomer stronger.

Silicone resins - have a three-dimensional structure with the atoms arranged tetrahedrally about the silicon atoms. Applied in solution in an organic solvent - electrical insulating varnish or paints where water repulsion needed - masonry.

Also used as an anti-stick surface for working with sticky foods. Hydroxyl groups on the resin react with hydroxyl groups on surfaces such as silica and glass, thus making the surface water-repellent.

A large range of silanes, which act as coupling agents, allows glass, minerals and metals to bond to organic polymers such as the acrylics, polyamides, urethanes and polyalkenes. Similar mechanisms enable resins to be used as adhesives.